

**ISO/IEC JTC 1/SC 17**

Date: 2000-07-13

**ISO/IEC FDIS 14443-3:2000(E)**

ISO/IEC JTC 1/SC 17/WG 8

Secretariat: DIN/AFNOR



## **Identification cards — Contactless integrated circuit(s) cards - Proximity cards — Part 3: Initialization and anticollision**

*Cartes d'identification — Cartes à circuit(s) intégrés sans contacts - Cartes de proximité — Partie 3 : Initialisation et anticollision*

Document type: International Standard

Document subtype:

Document stage: (50) Approval

Document language: E

M:\dms\dtic\dom315.1\iso\14443-3\ISO-IEC 14443-3 (E).doc STD Version 1.0

### Copyright notice

This ISO document is a Draft International Standard and is copyright-protected by ISO. Except as permitted under the applicable laws of the user's country, neither this ISO draft nor any extract from it may be reproduced, stored in a retrieval system or transmitted in any form or by any means, electronic, photocopying, recording or otherwise, without prior written permission being secured.

Requests for permission to reproduce should be addressed to ISO at the address below or ISO's member body in the country of the requester.

*Copyright Manager  
ISO Central Secretariat  
1 rue de Varembé  
1211 Geneva 20 Switzerland  
tel. + 41 22 749 0111  
fax + 41 22 734 1079  
internet: iso@iso.ch*

Reproduction may be subject to royalty payments or a licensing agreement.

Violators may be prosecuted.

## Contents

Foreword .....	v
1 Scope .....	1
2 Normative references .....	1
3 Terms and definitions.....	2
4 Symbols and abbreviated terms .....	3
5 Polling .....	5
6 Type A – Initialization and anticollision .....	5
6.1 Frame format and timing .....	5
6.1.1 Frame delay time .....	6
6.1.2 Frame delay time PCD to PICC.....	6
6.1.3 Frame delay time PICC to PCD.....	6
6.1.4 Request Guard Time.....	7
6.1.5 Frame formats.....	7
6.1.5.1 Short frame .....	7
6.1.5.2 Standard frame .....	7
6.1.5.3 Bit oriented anticollision frame .....	7
6.1.6 CRC_A.....	9
6.2 PICC states .....	9
6.2.1 POWER-OFF State .....	10
6.2.2 IDLE State .....	11
6.2.3 READY State .....	11
6.2.4 ACTIVE State.....	11
6.2.5 HALT State .....	11
6.2.6 READY* State .....	11
6.2.7 ACTIVE* State .....	12
6.3 Command set.....	12
6.3.1 REQA and WUPA Commands .....	12
6.3.2 ANTICOLLISION and SELECT Commands .....	13
6.3.3 HLTA Command.....	13
6.4 Select sequence.....	13
6.4.1 Select sequence flowchart .....	14
6.4.2 ATQA - Answer To Request .....	14
6.4.2.1 Coding of ATQA .....	15
6.4.2.2 Coding rules for bit frame anticollision.....	15
6.4.3 Anticollision and Select.....	16
6.4.3.1 Anticollision loop within each cascade level .....	16
6.4.3.2 Coding of SEL (Select code).....	17
6.4.3.3 Coding of NVB (Number of Valid Bits) .....	18
6.4.3.4 Coding of SAK (Select acknowledge).....	18
6.4.4 UID contents and cascade levels.....	19
7 Type B – Initialization and anticollision .....	21
7.1 Character, frame format and timing.....	21
7.1.1 Character transmission format .....	21
7.1.2 Character separation .....	21
7.1.3 Frame format.....	21
7.1.4 SOF.....	22
7.1.5 EOF.....	22
7.1.6 Timing before the PICC SOF .....	22
7.1.7 Timing before the PCD SOF .....	23

7.2	CRC_B.....	23
7.3	Anticollision sequence.....	24
7.4	PICC states description.....	24
7.4.1	State transition diagram.....	25
7.4.2	General statement for state description and transitions.....	26
7.4.3	POWER-OFF state.....	26
7.4.4	IDLE state.....	26
7.4.5	READY-REQUESTED sub-state.....	26
7.4.6	READY-DECLARED sub-state.....	27
7.4.7	ACTIVE state.....	27
7.4.8	HALT state.....	27
7.5	Command set.....	28
7.6	Anticollision response rules.....	28
7.7	REQB/WUPB Command.....	28
7.7.1	REQB/WUPB Command format.....	28
7.7.2	Coding of Anticollision Prefix byte APf.....	29
7.7.3	Coding of AFI.....	29
7.7.4	Coding of PARAM.....	29
7.8	Slot-MARKER Command.....	30
7.8.1	Slot-MARKER Command format.....	30
7.8.2	Coding of Anticollision Prefix byte APn.....	30
7.9	ATQB Response.....	31
7.9.1	ATQB Response format.....	31
7.9.2	PUPI (Pseudo-Unique PICC Identifier).....	31
7.9.3	Application Data.....	31
7.9.3.1	AFI.....	31
7.9.3.2	CRC_B(AID).....	31
7.9.3.3	Numbers of Applications.....	31
7.9.4	Protocol Info.....	32
7.9.4.1	FO.....	32
7.9.4.2	ADC.....	32
7.9.4.3	FWI.....	32
7.9.4.4	Protocol_Type.....	33
7.9.4.5	Max_Frame_Size.....	33
7.9.4.6	Bit_Rate_capability.....	33
7.10	ATTRIB Command.....	33
7.10.1	ATTRIB Command format.....	33
7.10.2	Identifier.....	34
7.10.3	Coding of Param 1.....	34
7.10.3.1	Minimum TR0.....	34
7.10.3.2	Minimum TR1.....	34
7.10.3.3	EOF/SOF.....	35
7.10.4	Coding of Param 2.....	35
7.10.5	Coding of Param 3.....	35
7.10.6	Coding of Param 4.....	36
7.10.7	Higher layer INF.....	36
7.11	Answer to ATTRIB Command.....	36
7.12	HLTB Command and Answer.....	37
Annex A (informative) Communication example Type A.....		38
Annex B (informative) CRC_A and CRC_B encoding.....		40
Annex C (informative) Type A timeslot – Initialization and anticollision.....		44
Annex D (informative) Type B - Example of Anticollision Sequence.....		47

## Foreword

ISO (the International Organization for Standardization) and IEC (the International Electrotechnical Commission) form the specialized system for worldwide standardization. National bodies that are members of ISO or IEC participate in the development of International Standards through technical committees established by the respective organization to deal with particular fields of technical activity. ISO and IEC technical committees collaborate in fields of mutual interest. Other international organizations, governmental and non-governmental, in liaison with ISO and IEC, also take part in the work.

International Standards are drafted in accordance with the rules given in the ISO/IEC Directives, Part 3.

In the field of information technology, ISO and IEC have established a joint technical committee, ISO/IEC JTC 1. Draft International Standards adopted by the joint technical committee are circulated to national bodies for voting. Publication as an International Standard requires approval by at least 75 % of the national bodies casting a vote.

Attention is drawn to the possibility that some of the elements of this part of ISO/IEC 14443 may be the subject of patent rights. ISO and IEC shall not be held responsible for identifying any or all such patent rights.

International Standard ISO/IEC 14443-3 was prepared by Joint Technical Committee ISO/IEC JTC 1, *Information technology*, Subcommittee SC 17, *Identification cards and related devices*.

ISO/IEC 14443 consists of the following parts, under the general title *Identification cards — Contactless integrated circuit(s) cards - Proximity cards*:

- *Part 1 : Physical characteristics*
- *Part 2 : Radio frequency power and signal interface*
- *Part 3 : Initialization and anticollision*
- *Part 4 : Transmission protocol*

Annexes A, B, C and D of this part of ISO/IEC 14443 are for information only.

## **Introduction**

ISO/IEC 14443 is one of a series of International Standards describing the parameters for identification cards as defined in ISO/IEC 7810, and the use of such cards for international interchange.

This part of ISO/IEC 14443 describes polling for proximity cards entering the field of a proximity coupling device, the byte format and framing, the initial Request and Answer to Request command content, methods to detect and communicate with one proximity card among several proximity cards (anticollision) and other parameters required to initialize communications between a proximity card and a proximity coupling device. Protocols and commands used by higher layers and by applications and which are used after the initial phase are described in ISO/IEC 14443-4.

ISO/IEC 14443 is intended to allow operation of proximity cards in the presence of other contactless cards conforming to ISO/IEC 10536 and ISO/IEC 15693.

# Identification cards — Contactless integrated circuit(s) cards - Proximity cards — Part 3: Initialization and anticollision

## 1 Scope

This part of ISO/IEC 14443 describes :

- polling for proximity cards (PICCs) entering the field of a proximity coupling device (PCD) ;
- the byte format, the frames and timing used during the initial phase of communication between PCDs and PICCs ;
- the initial Request and Answer to Request command content ;
- methods to detect and communicate with one PICC among several PICCs (anticollision) ;
- other parameters required to initialize communications between a PICC and PCD ;
- optional means to ease and speed up the selection of one PICC among several PICCs based on application criteria.

Protocol and commands used by higher layers and by applications and which are used after the initial phase are described in ISO/IEC 14443-4.

This part of ISO/IEC 14443 is applicable to PICCs of Type A and of Type B (as described in ISO/IEC 14443-2).

NOTE Part of the timing of data communication is defined in ISO/IEC 14443-2.

## 2 Normative references

The following normative documents contain provisions which, through reference in this text, constitute provisions of this part of ISO/IEC 14443. For dated references, subsequent amendments to, or revisions of, any of these publications do not apply. However, parties to agreements based on this part of ISO/IEC 14443 are encouraged to investigate the possibility of applying the most recent editions of the normative documents indicated below. For undated references, the latest edition of the normative document referred to applies. Members of ISO and IEC maintain registers of currently valid International Standards.

ISO/IEC 13239, *Information technology - Telecommunications and information exchange between systems - High-level data link control (HDLC) procedures.*

ISO/IEC 7816-3:1997, *Identification cards - Integrated circuit(s) cards with contacts - Part 3 : Electronic signals and transmission protocols.*

ISO/IEC 7816-5, *Identification cards – Integrated circuit(s) cards with contacts – Part 5 : Numbering system and registration procedure for application identifiers.*

ISO/IEC 7816-6:1996/AM1, *Identification cards – Integrated circuit(s) cards with contacts – Part 6 : Interindustry data elements – Amendment 1 : IC manufacturer's register.*

ISO/IEC 14443-2, *Identification cards – Contactless integrated circuit(s) cards – Proximity cards – Part 2 : Radio frequency power and signal interface.*

ISO/IEC 14443-4, *Identification cards – Contactless integrated circuit(s) cards – Proximity cards – Part 4 : Transmission protocol.*

ITU-T X.25, *Interface between Data Terminal Equipment (DTE) and Data Circuit-terminating Equipment (DCE) for terminals operating in the packet mode and connected to public data network by dedicated circuit.*

ITU-T V.41, *Code-independent error-control system.*

ITU-T V.42, *Error-correcting procedures for DLEs using asynchronous – to – synchronous conversion.*

### 3 Terms and definitions

For the purposes of this part of ISO/IEC 14443, the terms and definitions given in ISO/IEC 14443-2, ISO/IEC 7816-3 and the following apply.

#### 3.1 anticollision loop

algorithm used to prepare for dialogue between PCD and one or more PICCs out of the total number of PICCs responding to a request command.

#### 3.2 bit collision detection protocol

anticollision method for PICCs of Type A, employing collision detection at bit level within a frame.

#### 3.3 byte

a byte consists of 8 bits of data designated b8 to b1, from the most significant bit (MSB, b8) to the least significant bit (LSB, b1)

#### 3.4 collision

transmission by two PICCs in the same PCD energizing field and during the same time period, such that the PCD is unable to distinguish from which PICC the data originated

#### 3.5 elementary time unit (etu)

for this part of ISO/IEC 14443, one etu is defined as  $1 \text{ etu} = 128/f_c$  (i.e. 9,4  $\mu\text{s}$  nominal)

#### 3.6 frame

a frame is a sequence of data bits and optional error detection bits, with frame delimiters at start and end

#### 3.7 higher layer protocol

a protocol layer (not described in this part of ISO/IEC 14443) that makes use of the protocol layer defined in this part of ISO/IEC 14443 to transfer information belonging to the application or higher layers of protocol that is not described in this part of ISO/IEC 14443

#### 3.8 timeslot protocol

method whereby a PCD establishes logical channels with one or more PICCs of Type B, which makes use of timeslot allocation for PICC response



**3.9****request command**

command requesting PICC of the appropriate type to respond if they are available for initialization

**4 Symbols and abbreviated terms**

For the purposes of this part of ISO/IEC 14443, the following abbreviations are used :

ADC	Application Data Coding, Type B
AFI	Application Family Identifier. Card preselection criteria by application, Type B
APf	Anticollision Prefix f, used in REQb/WUPB, Type B
APn	Anticollision Prefix n, used in Slot-MARKER Command, Type B
ATQA	Answer To Request, Type A
ATQB	Answer To Request, Type B
ATTRIB	PICC selection command, Type B
BCC	UID CLn check byte, calculated as exclusive-or over the 4 previous bytes, Type A
CID	Card IDentifier
CLn	Cascade Level n, Type A
CT	Cascade Tag, Type A
CRC_A	Cyclic Redundancy Check error detection code A
CRC_B	Cyclic Redundancy Check error detection code B
E	End of communication, Type A
EGT	Extra Guard Time, Type B
EOF	End Of Frame, Type B
etu	Elementary time unit.
FDT	Frame Delay Time, Type A
fc	Carrier frequency
FO	Frame Option
fs	Subcarrier frequency
FWI	Frame Waiting time Integer
FWT	Frame Waiting Time
HLTA	Halt Command, Type A
HLTB	Halt Command, Type B

## ISO/IEC FDIS 14443-3:2000(E)

ID	IDentification number, Type A
INF	INformation field belonging to higher layer, Type B
LSB	Least Significant Bit
MBL	Maximum Buffer Length, Type B
MBLI	Maximum Buffer Length Index, Type B
MSB	Most Significant Bit
N	Number of anticollision slots or PICC response probability in each slot, Type B
n	Variable integer value as defined in the specific clause
NAD	Node ADdress
NVB	Number of Valid Bits, Type A
P	Odd Parity bit, Type A
PCD	Proximity Coupling Device
PICC	Proximity Card
PUPI	Pseudo-Unique PICC Identifier, Type B
R	Slot number chosen by the PICC during the anticollision sequence, Type B
REQA	Request Command, Type A
REQB	Request Command, Type B
RFU	Reserved for Future ISO/IEC Use
S	Start of communication, Type A
SAK	Select AcKnowledge, Type A
SEL	SElect code, Type A
SELECT	Select Command, Type A
SOF	Start Of Frame, Type B
TR0	Guard Time as defined in ISO/IEC 14443-2, Type B
TR1	Synchronization Time as defined in ISO/IEC 14443-2, Type B
UID	Unique Identifier, Type A
uid <i>n</i>	Byte number <i>n</i> of Unique IDentifier, $n \geq 0$
WUPA	Wake-UP Command, Type A
WUPB	Wake-UP Command, Type B

For the purposes of this part of ISO/IEC 14443, the following notation applies :

- (xxxxx)b Data bit representation ;
- 'XY' Hexadecimal notation, equal to XY to the base 16.

## 5 Polling

In order to detect PICCs which are in the operating field, a PCD shall send repeated Request commands. The PCD shall send REQA and REQB described herein in any sequence and in addition may send other commands as described in Annex C.

When a PICC is exposed to an unmodulated operating field (see ISO/IEC 14443-2) it shall be able to accept a request within 5 ms.

EXAMPLE 1 When a PICC Type A receives any Type B command it shall be able to accept a REQA within 5 ms of unmodulated operating field.

EXAMPLE 2 When a PICC Type B receives any Type A command it shall be able to accept a REQB within 5 ms of unmodulated operating field.

## 6 Type A – Initialization and anticollision

This section describes the initialization and collision detection protocol applicable for PICCs of Type A.

The PCD shall be designed to detect a collision that occurs when at least two PICCs simultaneously transmit bit patterns with one or more bit positions in which at least two PICCs transmit complementary values. In this case the bit patterns merge and the carrier is modulated with the subcarrier for the whole (100%) bit duration (see ISO/IEC 14443-2).

### 6.1 Frame format and timing

This section defines the frame format and timing used during communication initialization and anticollision. For bit representation and coding refer to ISO/IEC 14443-2.

Frames shall be transferred in pairs, PCD to PICC followed by PICC to PCD, using the sequence:

- PCD frame :
  - PCD start of communication
  - information and, where required, error detection bits sent by the PCD
  - PCD end of communication
- Frame delay time PCD to PICC
- PICC frame :
  - PICC start of communication
  - information and, where required, error detection bits sent by the PICC
  - PICC end of communication
- Frame delay time PICC to PCD

The frame delay time (FDT) from PCD to PICC overlaps the PCD end of communication.

6.1.1 Frame delay time

The frame delay time FDT is defined as the time between two frames transmitted in opposite directions.

6.1.2 Frame delay time PCD to PICC

This is the time between the end of the last pause transmitted by the PCD and the first modulation edge within the start bit transmitted by the PICC and shall respect the timing defined in Figure 1, where  $n$  is an integer value.

Table 1 defines values for  $n$  and FDT depending on the command type and the logic state of the last transmitted data bit in this command.

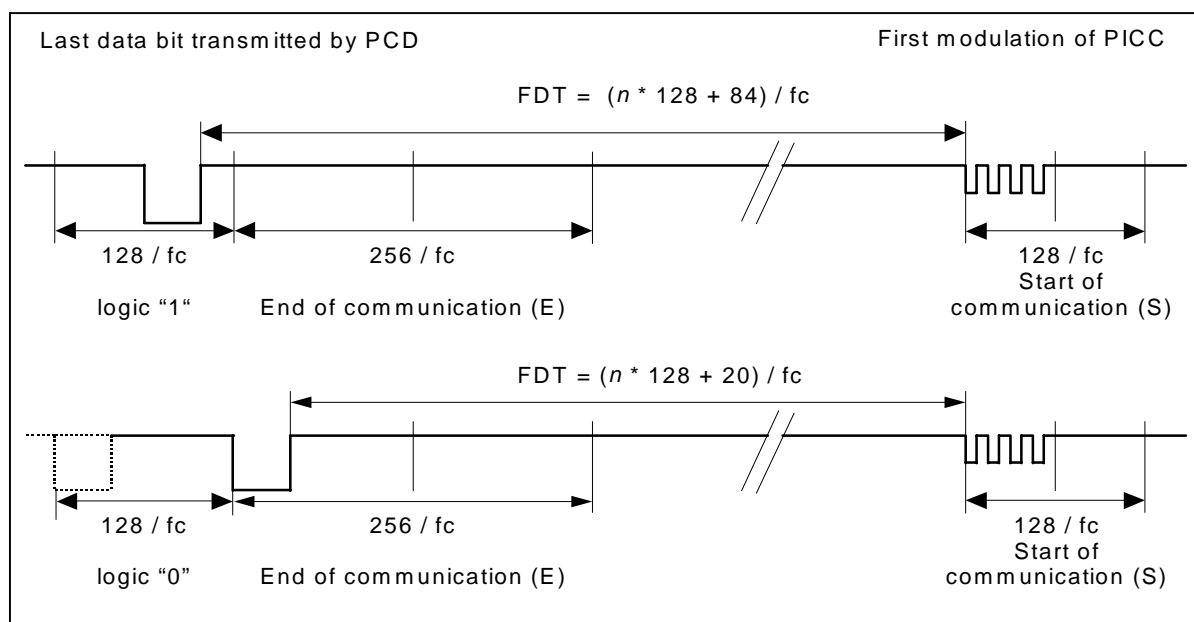

Figure 1 — Frame delay time PCD to PICC

Table 1 — Frame delay time PCD to PICC

Command type	$n$ (integer value)	FDT	
		last bit = (1)b	last bit = (0)b
REQA Command WUPA Command ANTICOLLISION Command SELECT Command	9	1236 / fc	1172 / fc
All other commands	$\geq 9$	$(n * 128 + 84) / fc$	$(n * 128 + 20) / fc$

The value  $n = 9$  means that all PICCs in the field shall respond in a synchronous way which is needed for anticollision.

For all other commands the PICC shall ensure that the first modulation edge within the start bit is aligned to the bit-grid defined in Figure 1.

6.1.3 Frame delay time PICC to PCD

This is the time between the last modulation transmitted by the PICC and the first pause transmitted by the PCD and shall be at least 1172 / fc.

**6.1.4 Request Guard Time**

The Request Guard Time is defined as the minimum time between the start bits of two consecutive REQA commands. It has the value 7000 / fc.

**6.1.5 Frame formats**

The following frame types are defined :

- short frames for commands defined in Table 2 ;
- standard frames for regular commands ;
- bit oriented anticollision frame for anticollision command.

**6.1.5.1 Short frame**

A short frame is used to initiate communication and consists of, in the following order :

- start of communication ;
- 7 data bits transmitted LSB first (for coding see Table 2) ;
- end of communication.

No parity bit is added.

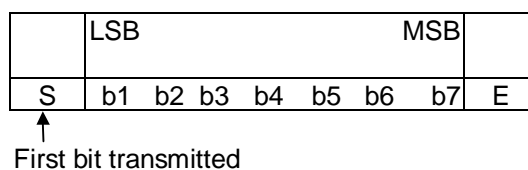
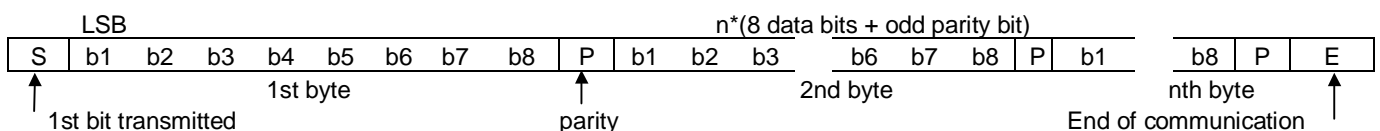

**Figure 2 — Short frame**

**6.1.5.2 Standard frame**

Standard frames are used for data exchange and consist of :

- start of communication ;
- n \* (8 data bits + odd parity bit), with n ≥ 1. The LSB of each byte is transmitted first. Each byte is followed by an odd parity bit. The parity bit P is set such that the number of 1s is odd in (b1 to b8, P) ;
- end of communication.



**Figure 3 — Standard Frame**

**6.1.5.3 Bit oriented anticollision frame**

A collision is detected when at least two PICCs transmit different bit patterns to the PCD. In this case the carrier is modulated with the subcarrier for the whole bit duration for at least one bit.

Bit oriented anticollision frames shall only be used during bit frame anticollision loops and are standard frames with a length of 7 bytes, split into two parts :

- part 1 for transmission from PCD to PICC ;
- part 2 for transmission from PICC to PCD.

For the length of part 1 and part 2, the following rules shall apply :

- rule 1 : The sum of data bits shall be 56 ;
- rule 2 : The minimum length of part 1 shall be 16 data bits ;
- rule 3 : The maximum length of part 1 shall be 55 data bits.

Consequently, the minimum length of part 2 shall be 1 data bit and the maximum length shall be 40 data bits.

Since the split can occur at any bit position within a byte, two cases are defined :

- case FULL BYTE: Split after a complete byte. A parity bit is added after the last data bit of part 1 ;
- case SPLIT BYTE: Split within a byte. No parity bit is added after the last data bit of part 1.

The following examples for case FULL BYTE and case SPLIT BYTE define the bit organization and order of bit transmission.

NOTE These examples include proper values for NVB and BCC.

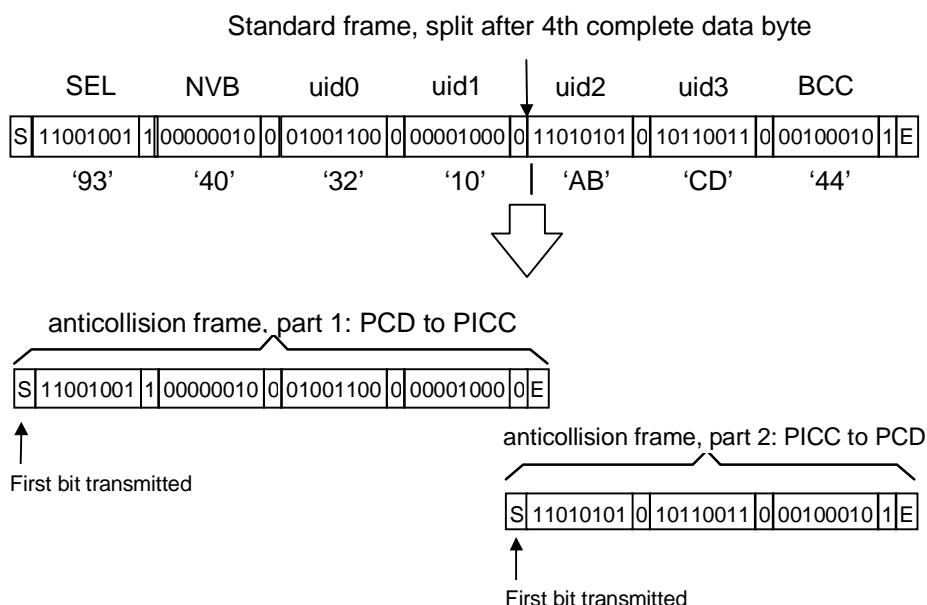
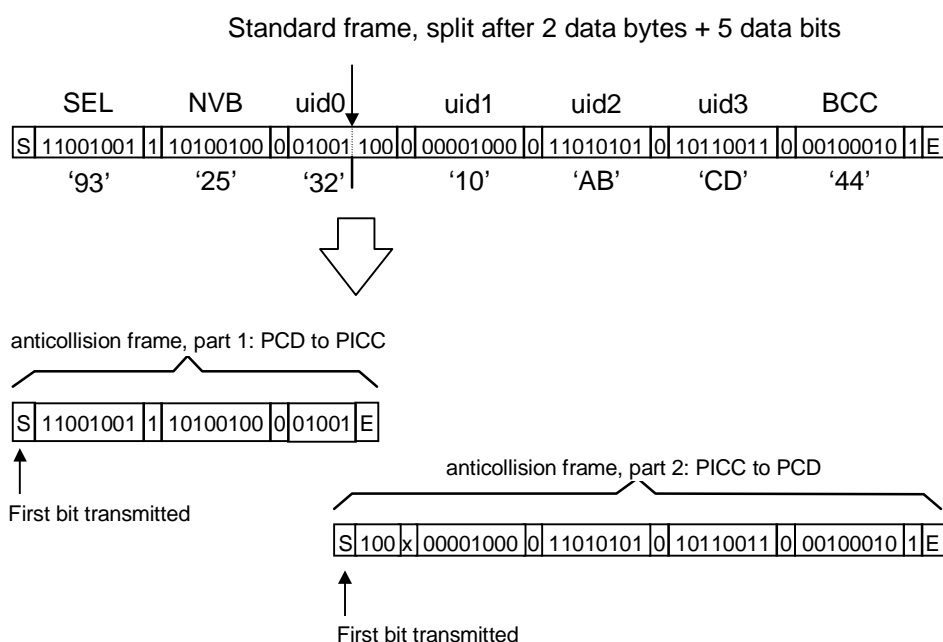

Figure 4 — Bit organization and transmission of bit oriented anticollision frame, case FULL BYTE



**Figure 5 — Bit organization and transmission of bit oriented anticollision frame, case SPLIT BYTE**

For a SPLIT BYTE, the first parity bit of part 2 shall be ignored by the PCD.

### 6.1.6 CRC\_A

The frame CRC\_A is a function of  $k$  data bits, which consist of all the data bits in the frame, excluding parity bits, S and E, and the CRC\_A itself. Since data is encoded in bytes, the number of bits  $k$  is a multiple of 8. For error checking, the two CRC\_A bytes are sent in the standard frame, after the bytes and before the E. The CRC\_A is as defined in ISO/IEC 13239, but the initial register content shall be '6363' and the register content shall not be inverted after calculation.

For an example refer to annex B.

## 6.2 PICC states

The following sections provide descriptions of the states for a PICC of Type A specific to the bit collision detection protocol.

The following state diagram takes all possible state transitions caused by commands of this part of ISO/IEC 14443 into account.

PICCs react to valid received frames only. No response is sent when transmission errors are detected.

The following symbols apply for the state diagram shown in Figure 6 below.

AC	ANTICOLLISION Command (matched UID)
nAC	ANTICOLLISION Command (not matched UID)
SELECT	SELECT Command (matched UID)
nSELECT	SELECT Command (not matched UID)

DESELECT DESELECT Command, defined in ISO/IEC 14443-4

Error transmission error detected

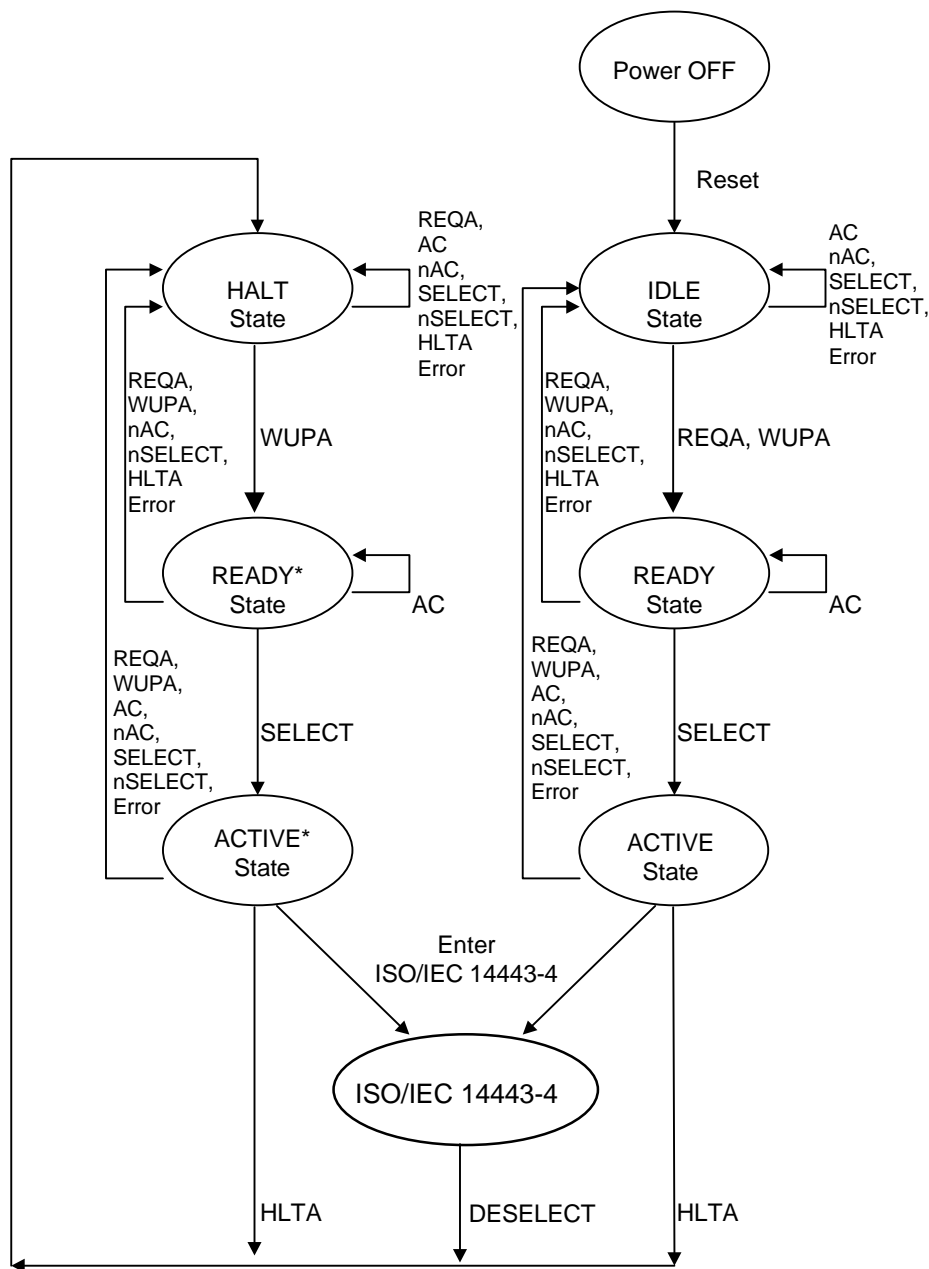

Figure 6 — PICC Type A state diagram

PICCs being compliant with ISO/IEC 14443-3 but not using ISO/IEC 14443-4 may leave the ACTIVE or ACTIVE\* State by proprietary commands.

6.2.1 POWER-OFF State

Description :

In the POWER-OFF State, the PICC is not powered due to a lack of carrier energy.



**State exit conditions and transitions :**

If the PICC is in an energizing magnetic field greater than  $H_{min}$  (see ISO/IEC 14443-2), it shall enter its IDLE State within a delay not greater than defined in clause 5.

**6.2.2 IDLE State****Description :**

In the IDLE State, the PICC is powered. It listens for commands and shall recognize REQA and WUPA Commands.

**State exit conditions and transitions :**

The PICC enters the READY State after it has received a valid REQA or WUPA Command and transmitted its ATQA.

**6.2.3 READY State****Description :**

In the READY State, either the bit frame anticollision or a proprietary anticollision method can be applied. Cascade levels are handled inside this state to get the complete UID.

**State exit conditions and transitions :**

The PICC enters the ACTIVE State when it is selected with its complete UID.

**6.2.4 ACTIVE State****Description :**

In the ACTIVE State, the PICC listens to any higher layer message.

**State exit conditions and transitions :**

The PICC enters the HALT State when a valid HLTA Command is received.

NOTE In the higher layer protocol, specific commands may be defined to return the PICC to its HALT State.

**6.2.5 HALT State****Description :**

In the HALT State, the PICC shall respond only to a WUPA Command.

**State exit conditions and transitions :**

The PICC enters the READY\* State after it has received a valid WUPA Command and transmitted its ATQA.

**6.2.6 READY\* State****Description :**

The READY\* State is similar to the READY State, either the bit frame anticollision or a proprietary anticollision method can be applied. Cascade levels are handled inside this state to get complete UID.

**State exit conditions and transitions :**

The PICC enters the ACTIVE\* State when it is selected with its complete UID.

**6.2.7 ACTIVE\* State**

**Description :**

The ACTIVE\* State is similar to the ACTIVE State, the PICC is selected and listens to any higher layer message.

**State exit conditions and transitions :**

The PICC enters the HALT State when a valid HLTA Command is received.

**6.3 Command set**

The commands used by the PCD to manage communication with several PICCs are :

- REQA ;
- WUPA ;
- ANTICOLLISION ;
- SELECT ;
- HLTA.

The commands use the byte and frame formats described above.

**6.3.1 REQA and WUPA Commands**

The REQA and WUPA Commands are sent by the PCD to probe the field for PICCs of Type A. They are transmitted within a short frame.

See Figure 6 to check in which cases PICC actually have to answer to these respective commands.

Particularly the WUPA Command is sent by the PCD to put PICCs which have entered the HALT State back into the READY\* State. They shall then participate in further anticollision and selection procedures.

Table 2 shows the coding of REQA and WUPA Commands which use the Short frame format.

**Table 2 — Coding of Short Frame**

b7	b6	b5	b4	b3	b2	b1	Meaning
0	1	0	0	1	1	0	'26' = REQA
1	0	1	0	0	1	0	'52' = WUPA
0	1	1	0	1	0	1	'35' = Optional timeslot method, see Annex C
1	0	0	x	x	x	x	'40' to '4F' = Proprietary
1	1	1	1	x	x	x	'78' to '7F' = Proprietary
all other values							RFU

### 6.3.2 ANTICOLLISION and SELECT Commands

These commands are used during an anticollision loop (see Figure 4 and 5). The ANTICOLLISION and SELECT Commands consist of :

- select code SEL (1 byte) ;
- number of valid bits NVB (1 byte, for coding see Table 7) ;
- 0 to 40 data bits of UID CL<sub>n</sub> according to the value of NVB.

SEL specifies the cascade level CL<sub>n</sub>.

The ANTICOLLISION Command is transmitted within bit oriented anticollision frame.

The SELECT Command is transmitted within standard frame

As long as NVB does not specify 40 valid bits, the command is called ANTICOLLISION Command, where the PICC remains in READY or READY\* State.

If NVB specifies 40 data bits of UID CL<sub>n</sub> (NVB='70'), a CRC\_A shall be appended. This command is called SELECT Command.

If the PICC has transmitted the complete UID, it transits from READY State to ACTIVE State or from READY\* State to ACTIVE\* State and indicates in its SAK response that UID is complete.

Otherwise, the PICC remains in READY or READY\* state and the PCD shall initiate a new anticollision loop with increased cascade level.

### 6.3.3 HLTA Command

The HLTA Command consists of two bytes followed by CRC\_A and shall be transmitted within Standard Frame.

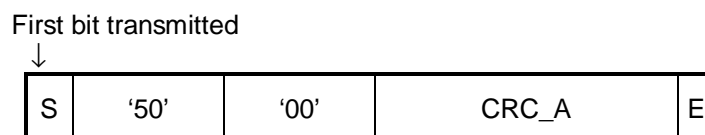

**Figure 7 — Standard frame containing HLTA Command**

If the PICC responds with any modulation during a period of 1 ms after the end of the frame containing the HLTA Command, this response shall be interpreted as 'not acknowledge'.

## 6.4 Select sequence

The purpose of the select sequence is to get the UID from one PICC and to select this PICC for further communication.

6.4.1 Select sequence flowchart

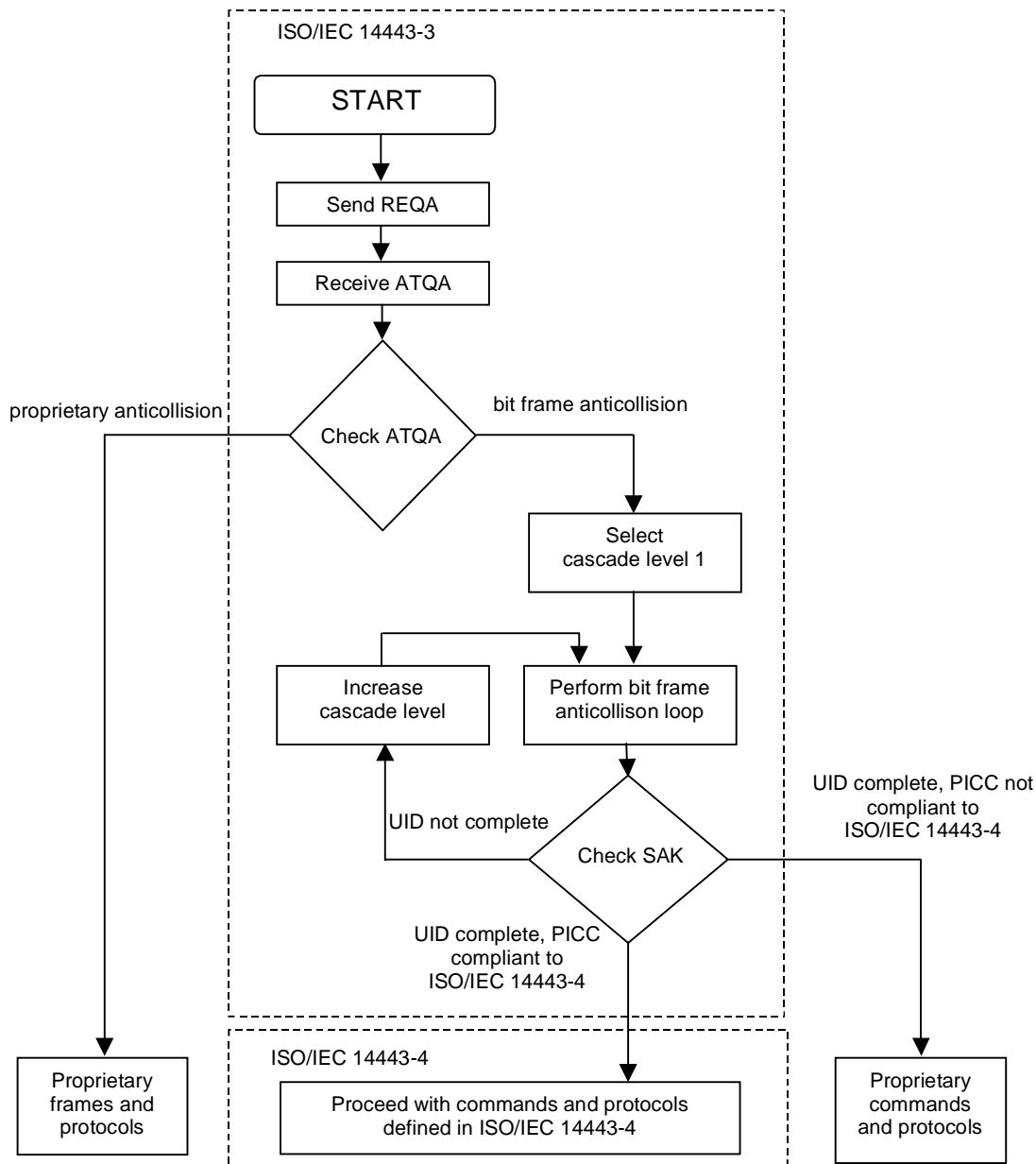

Figure 8 — Initialization and anticollision flowchart for PCD

6.4.2 ATQA - Answer To Request

After a REQA Command is transmitted by the PCD, all PICCs in the IDLE state shall respond synchronously with ATQA.

After a WUPA Command is transmitted by the PCD, all PICCs in the IDLE or HALT state shall respond synchronously with ATQA.

The PCD shall detect any collision that may occur when multiple PICCs respond.

An example is given in annex A.

## 6.4.2.1 Coding of ATQA

Table 3 — Coding of ATQA

MSB											LSB				
b16	b15	b14	b13	b12	b11	b10	b9	b8	b7	b6	b5	b4	b3	b2	b1
RFU				Proprietary coding				UID size bit frame		RFU	Bit frame anticollision				

All RFU bits shall be set to 0.

## 6.4.2.2 Coding rules for bit frame anticollision

- Rule 1 : Bits b7 and b8 code the UID size (single, double or triple, see Table 4).
- Rule 2 : One out of the five bits b1, b2, b3, b4 or b5 shall be set to (1)b to indicate bit frame anticollision (see Table 5)

NOTE Bit 9 to bit 12 indicate additional and proprietary methods

Table 4 — Coding of b7, b8 for bit frame anticollision

b8	b7	Meaning
0	0	UID size: single
0	1	UID size: double
1	0	UID size: triple
1	1	RFU

Table 5 — Coding of b1 - b5 for bit frame anticollision

b5	b4	b3	b2	b1	Meaning
1	0	0	0	0	bit frame anticollision
0	1	0	0	0	bit frame anticollision
0	0	1	0	0	bit frame anticollision
0	0	0	1	0	bit frame anticollision
0	0	0	0	1	bit frame anticollision

6.4.3 Anticollision and Select

6.4.3.1 Anticollision loop within each cascade level

The following algorithm shall apply to the anticollision loop :

Step 1	The PCD shall assign SEL with the code for the selected anticollision type and cascade level.
Step 2	The PCD shall assign NVB with the value of '20'. NOTE This value defines that the PCD will transmit no part of UID CLn. Consequently this command forces all PICCs in the field to respond with their complete UID CLn.
Step 3	The PCD shall transmit SEL and NVB.
Step 4	All PICCs in the field shall respond with their complete UID CLn.
Step 5	Assuming the PICCs in the field have unique serial numbers, then if more than one PICC responds, a collision occurs. If no collision occurs, steps 6 to 10 shall be skipped.
Step 6	The PCD shall recognize the position of the first collision.
Step 7	The PCD shall assign NVB with a value that specifies the number of valid bits of UID CLn. The valid bits shall be part of the UID CLn that was received before a collision occurred followed by a (0)b or (1)b, decided by the PCD. A typical implementation adds a (1)b.
Step 8	The PCD shall transmit SEL and NVB, followed by the valid bits.
Step 9	Only PICCs of which the part of UID CLn is equal to the valid bits transmitted by the PCD shall transmit their remaining bits of the UID CLn.
Step 10	If further collisions occur, steps 6 to 9 shall be repeated. The maximum number of loops will be 32.
Step 11	If no further collision occurs, the PCD shall assign NVB with the value of '70'. NOTE This value defines that the PCD will transmit the complete UID CLn.
Step 12	The PCD shall transmit SEL and NVB, followed by all 40 bits of UID CLn, followed by CRC_A checksum.
Step 13	The PICC which UID CLn matches the 40 bits shall respond with its SAK.
Step 14	If the UID is complete, the PICC shall transmit SAK with cleared cascade bit and shall transit from READY State to ACTIVE State or from READY* State to ACTIVE* State.
Step 15	The PCD shall check if the cascade bit of SAK is set to decide whether further anticollision loops with increased cascade level shall follow.

If the UID of a PICC is complete and known by the PCD, the PCD may skip step 2 - step 10 to select this PICC without performing the anticollision loop.

NOTE Figure 9 explains steps 1 to 13.

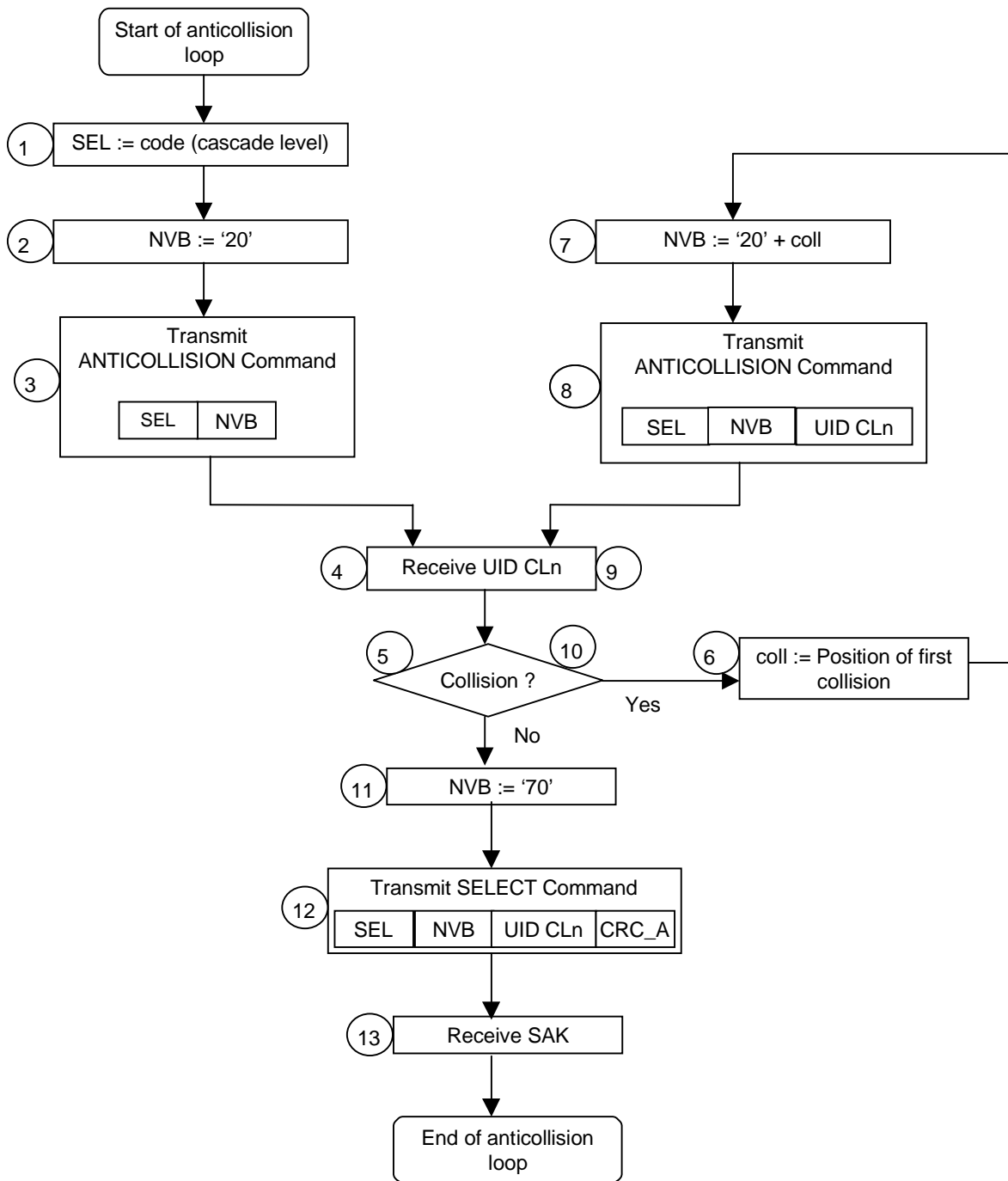

Figure 9 — Anticollision loop, flowchart for PCD

NOTE The circled numbers correspond to the steps of the algorithm.

### 6.4.3.2 Coding of SEL (Select code)

Length : 1 byte

Possible values : '93', '95', '97'

**Table 6 — Coding of SEL**

b8	b7	b6	b5	b4	b3	b2	b1	Meaning
1	0	0	1	0	0	1	1	'93': Select cascade level 1
1	0	0	1	0	1	0	1	'95': Select cascade level 2
1	0	0	1	0	1	1	1	'97': Select cascade level 3
1	0	0	1	other values except those here above				RFU

**6.4.3.3 Coding of NVB (Number of Valid Bits)**

Length : 1 byte

The upper 4 bits are called “Byte count” and specify the integer part of the number of all valid data bits transmitted by the PCD (including SEL and NVB) divided by 8. Consequently, the minimum value of “Byte count” is 2 and the maximum value is 7.

The lower 4 bits are called “bit count” and specify the number of all valid data bits transmitted by the PCD (including SEL and NVB) modulo 8.

**Table 7 — Coding of NVB**

b8	b7	b6	b5	Meaning
0	0	1	0	Byte count = 2
0	0	1	1	Byte count = 3
0	1	0	0	Byte count = 4
0	1	0	1	Byte count = 5
0	1	1	0	Byte count = 6
0	1	1	1	Byte count = 7

b4	b3	b2	b1	Meaning
0	0	0	0	bit count = 0
0	0	0	1	bit count = 1
0	0	1	0	bit count = 2
0	0	1	1	bit count = 3
0	1	0	0	bit count = 4
0	1	0	1	bit count = 5
0	1	1	0	bit count = 6
0	1	1	1	bit count = 7

**6.4.3.4 Coding of SAK (Select acknowledge)**

SAK is transmitted by the PICC when NVB has specified 40 valid data bits and when all these data bits match with UID CLn.

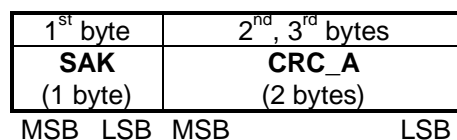

**Figure 10 — Select acknowledge (SAK)**

The coding of bits b3 (cascade bit) and b6 is given in Table 8.



Table 8 — Coding of SAK

b8	b7	b6	b5	b4	b3	b2	b1	Meaning
x	x	x	x	x	1	x	x	Cascade bit set: UID not complete
x	x	1	x	x	0	x	x	UID complete, PICC compliant with ISO/IEC 14443-4
x	x	0	x	x	0	x	x	UID complete, PICC not compliant with ISO/IEC 14443-4

#### 6.4.4 UID contents and cascade levels

The UID consists of 4, 7 or 10 UID bytes. Consequently, the PICC shall handle up to 3 cascade levels to get all UID bytes. Within each cascade level, a part of UID shall be transmitted to the PCD. According to the cascade level, three types of UID size are defined. This UID size shall be consistent with Table 4.

Table 9 — UID size

Cascade level	UID size	Number of UID bytes
1	single	4
2	double	7
3	triple	10

The UID is a fixed unique number or a random number which is dynamically generated by the PICC. The first byte (uid0) of the UID assigns the content of the following bytes of the UID.

Table 10 — Single size UIDs

uid0	Description
'08'	uid1 to uid3 is a random number which is dynamically generated
'x0' - 'x7'	proprietary fixed number
'x9' - 'xE'	
'18' - 'F8'	RFU
'xF'	

The value '88' of the cascade tag CT shall not be used for uid0 in single size UID.

Table 11 — Double and triple size UIDs

uid0	Description
Manufacturer ID according to ISO/IEC 7816-6/AM1*	Each manufacturer is responsible for the uniqueness of the value of the other bytes of the unique number.
* The values '81' to 'FE', which are marked for 'Private use' in ISO/IEC 7816-6/AM1 shall not be allowed in this context.	

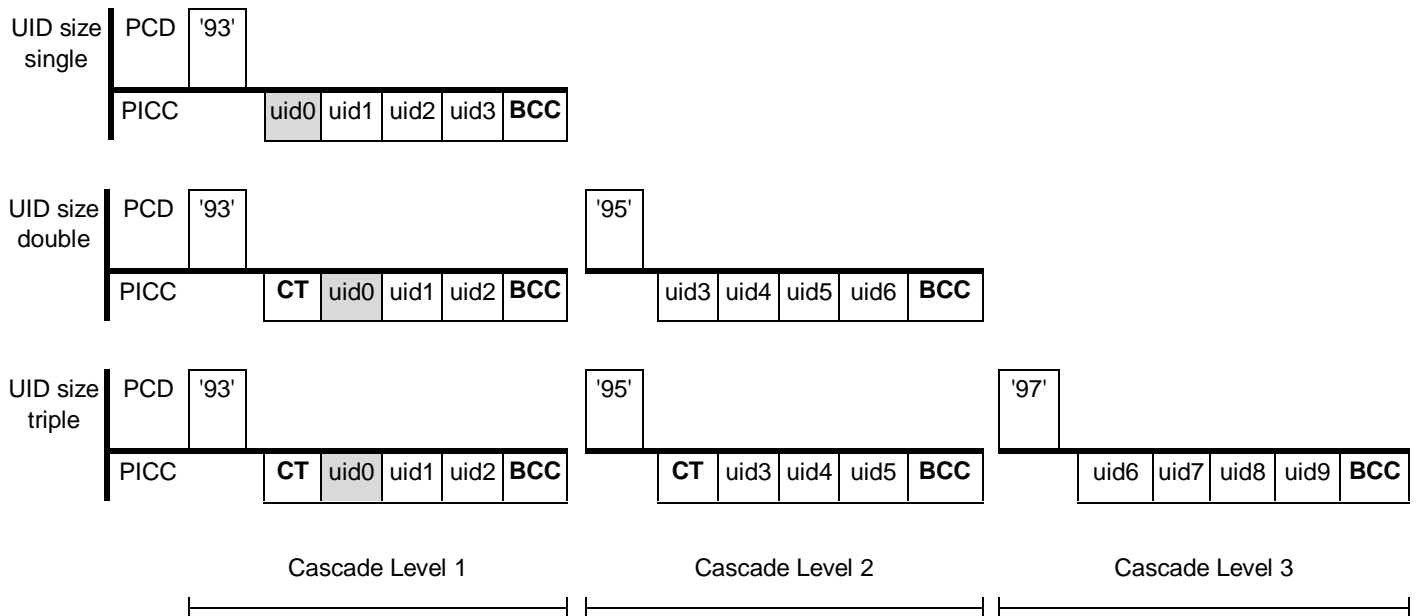

**Figure 11 — Usage of cascade levels**

NOTE The purpose of the cascade tag is to force a collision with PICCs that have a smaller UID size.

The following algorithm shall apply to the PCD to get the complete UID :

Step 1	The PCD selects cascade level 1
Step 2	The anticollision loop shall be performed
Step 3	The PCD shall check the cascade bit of SAK
Step 4	If the cascade bit is set, the PCD shall increase the cascade level and initiate a new anticollision loop

## 7 Type B – Initialization and anticollision

This section describes the initialization and collision detection protocol applicable for PICCs of Type B.

### 7.1 Character, frame format and timing

This section defines the character, frame format and timing used during communication initialization and anticollision for PICCs of Type B. For bit representation and coding refer to ISO/IEC 14443-2.

#### 7.1.1 Character transmission format

Bytes are transmitted and received between PICCs and a PCD by characters, the format of which during the Anti-collision sequence is as follows :

- 1 start bit at logic "0" ;
- 8 data bits transmitted, LSB first ;
- 1 stop bit at logic "1".

The transmission of one byte is performed with a character requiring 10 etu as illustrated below.

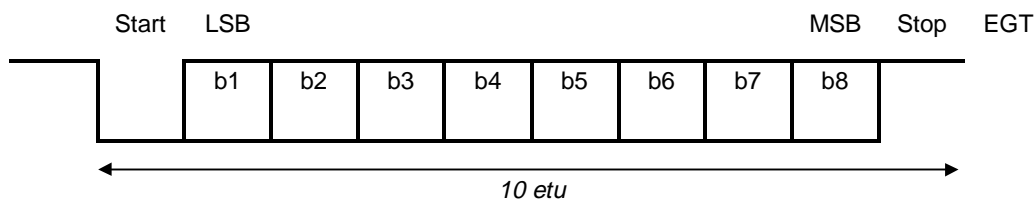

Figure 12 — Character format

Bit boundaries within a character shall occur between  $(n - 0,125)$  etu and  $(n + 0,125)$  etu where  $n$  is the number of bit boundaries after the start bit falling edge ( $1 \leq n \leq 9$ ).

#### 7.1.2 Character separation

A character is separated from the next one by the extra guard time EGT.

The EGT between 2 consecutive characters sent by the PCD to the PICC shall be between 0 and 57  $\mu$ s.

The EGT between 2 consecutive characters sent by the PICC to the PCD shall be between 0 and 19  $\mu$ s.

#### 7.1.3 Frame format

PCDs and PICCs shall send characters as frames. The frame is normally delimited by SOF and by EOF. See 7.10.3 for exceptions.

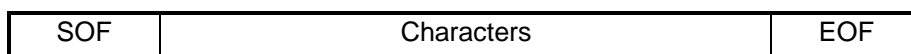

Figure 13 — Frame Format

7.1.4 SOF

SOF is composed of :

- one falling edge ;
- followed by 10 etu with a logic "0" ;
- followed by one single rising edge located anywhere within the following etu ;
- followed by at least 2 etu (but no more than 3 etu) with a logic "1".

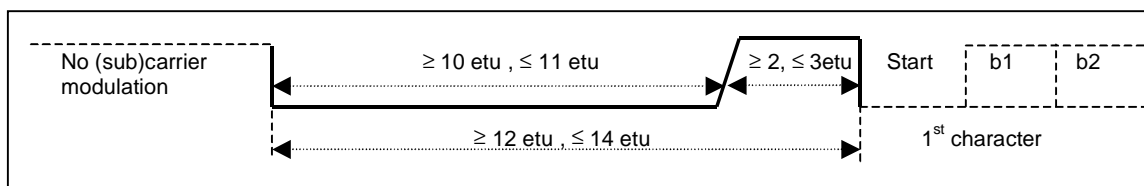

Figure 14 — SOF

7.1.5 EOF

EOF is composed of :

- one falling edge ;
- followed by 10 etu with a logic "0" ;
- followed by one single rising edge located anywhere within the following etu.

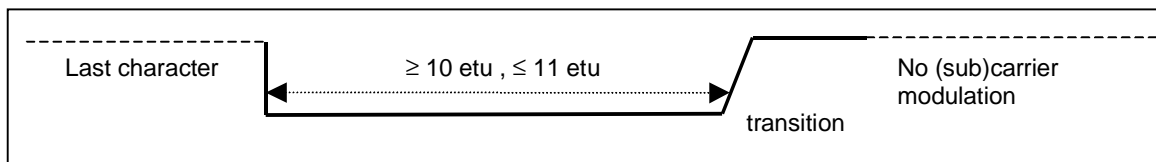

Figure 15 — EOF

NOTE The probability of receiving a false EOF is low and corresponds to the transmission of a '00' character with a wrong reception of the stop bit.

7.1.6 Timing before the PICC SOF

PICC start of communication after a PCD data transmission shall respect the timing defined in Figure 16.

The default minimum values of TR0 and TR1 are defined in ISO/IEC 14443-2 and may be reduced by the PCD, see 7.10.3.

The maximum value of TR0 is 256/fs for ATQB only and  $(256/fs) * 2^{FWI}$  for all other frames (see 7.9.4.3).

The maximum value of TR1 is 200/fs.

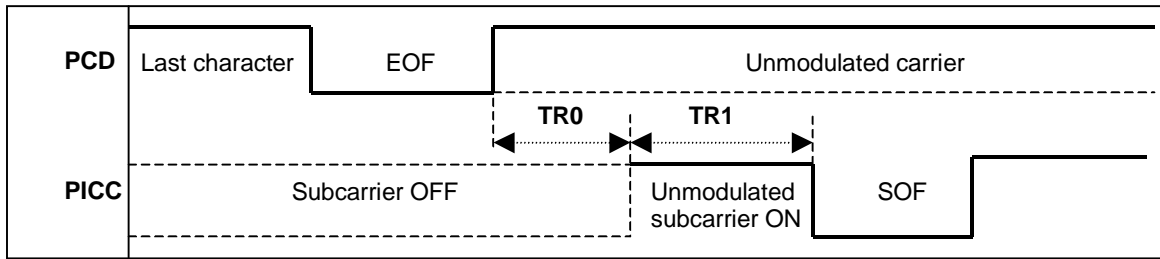

Figure 16 — PICC subcarrier SOF

A PICC may turn on the subcarrier only if it intends to begin transmitting information.

7.1.7 Timing before the PCD SOF

PCD start of communication after a PICC data transmission and EOF shall respect the timing in Figure 17.

The PICC shall turn off its subcarrier after the transmission of the EOF. The subcarrier signal shall :

- not be stopped before the end of the EOF ;
- be stopped no later than 2 etu after the end of the EOF.

The minimum delay between the PICC EOF start (falling edge) and the PCD SOF start (falling edge) is  $10 \text{ etu} + 32 / f_s$ .

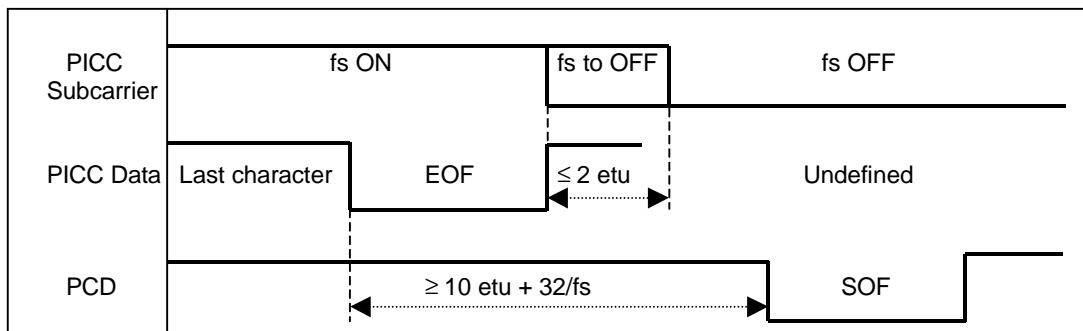

Figure 17 — PICC to PCD EOF

7.2 CRC\_B

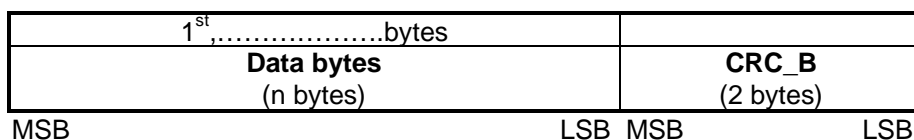

Figure 18 — Position of a CRC\_B within a frame

A frame shall only be considered correct if it is received with a valid CRC\_B value.

The frame CRC\_B is a function of k data bits, which consist of all the data bits in the frame, excluding start bits, stop bits, delays between bytes, SOF and EOF, and the CRC\_B itself. Since data is encoded in bytes, the number of bits k is a multiple of 8.

For error checking, the two CRC\_B bytes are included in the frame, after the data bits and before the EOF. The CRC\_B is as defined in ISO/IEC 13239. The initial register content shall be all ones: 'FFFF'.

For example refer to annex B.

### 7.3 Anticollision sequence

An anticollision sequence is managed by the PCD through a set of commands detailed in this section.

The PCD is the master of the communication with one or more PICCs. It initiates PICC communication activity by issuing a REQB Command to prompt for PICCs to respond.

During the anticollision sequence it may happen that two or more PICCs respond simultaneously : this is a collision. The command set allows the PCD to handle sequences to separate PICC transmissions in time. The PCD may repeat its anticollision procedure until it finds all PICCs in the operating volume.

Having completed the anticollision sequence, PICC communication will be under control of the PCD, allowing only one PICC to talk at a time.

The anticollision scheme is based on definition of timeslots in which PICCs are invited to answer with minimum identification data. The number of slots is parameterized in the REQB/WUPB and can vary from one to some integer number. PICC response probability in each timeslot is also controllable. PICCs are allowed to answer only once in the anticollision sequence.

Consequently, even in case of multiple PICCs present in the PCD field, there will probably be a slot in which only one PICC answers and where the PCD is able to capture the identification data. Based on the identification data the PCD is able to establish a communication channel with the identified PICC.

An anticollision sequence allows selection of one or more PICCs for further communication at any time.

The set of commands allows implementation of different anticollision management strategies at the PCD level. This strategy is under the control of the application designer and can include :

- probabilistic (repetitive single slot prompt with response probability less than or equal to 1) ;
- pseudo-deterministic (multiple slots with scanning of them during the anticollision sequence to have the maximum probability that all present PICCs answer) ;
- any combination of these methods that can be conducted dynamically.

### 7.4 PICC states description

Different states and transition conditions between states describe the PICC detailed behaviour during the anticollision sequence.

7.4.1 State transition diagram

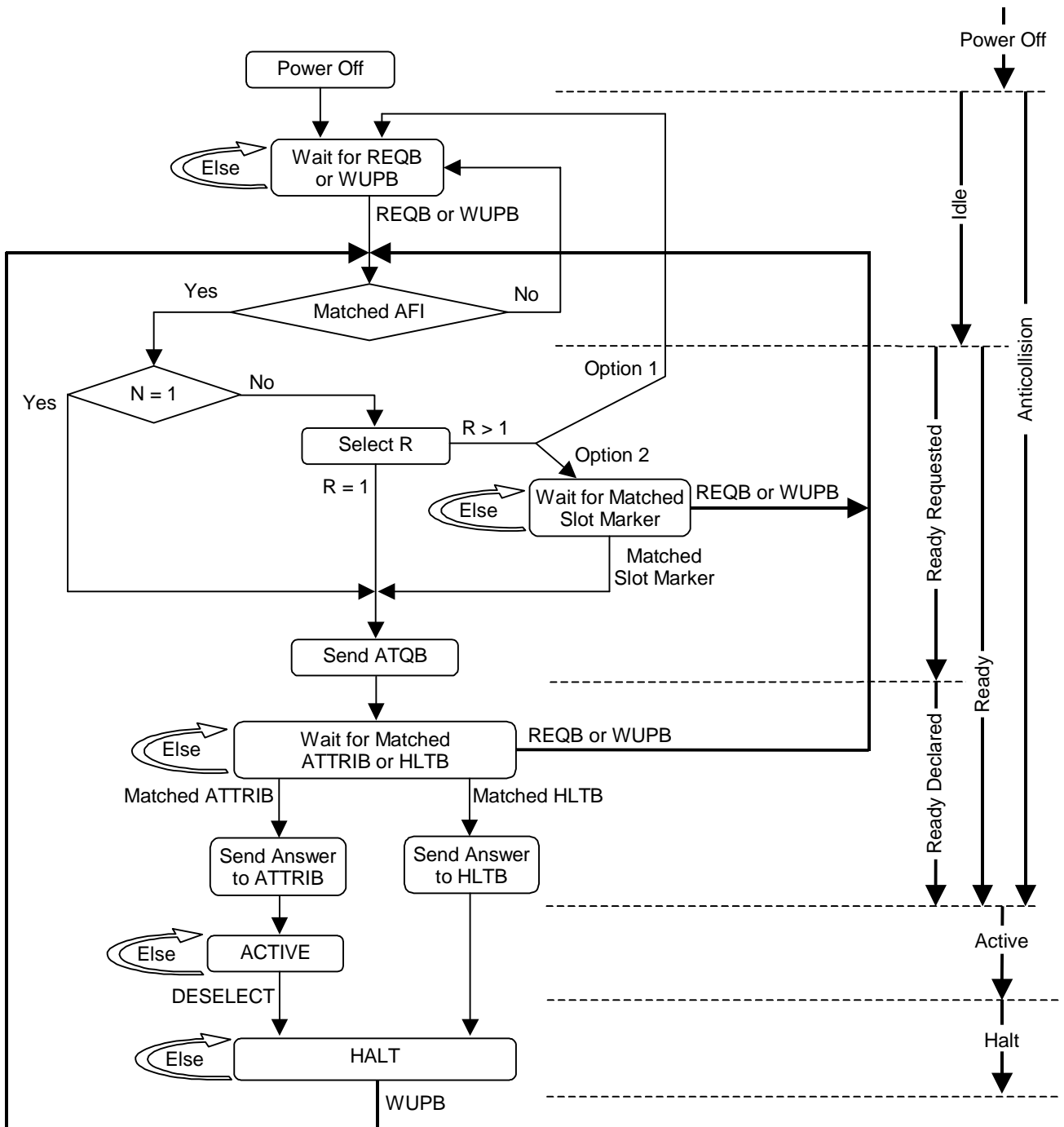

Figure 19 — PICC state transition flowchart example

NOTE 1 R is a random number chosen by the PICC in the range from 1 to N (for coding of N see 7.7.4).

NOTE 2 Option 1 – For PICCs not supporting Slot-MARKER Command (Probabilistic approach).

Option 2 – For PICCs supporting Slot-MARKER Command (Timeslot approach).

#### 7.4.2 General statement for state description and transitions

To any state the following shall apply :

- the PICC shall return to POWER\_OFF State if the RF field disappears.

To any state specific to the anticollision sequence (except ACTIVE state) the following shall apply :

- default communication parameters as defined in ISO/IEC 14443-2 and in the previous sections shall be used ;
- the PICC shall not emit subcarrier except to transmit response frames as specified in the previous sections ;
- if a frame from the PCD is valid (correct CRC\_B), the PICC shall perform the required action and/or response depending on its state ;
- as in anticollision commands the first 3 bits of the data in a frame are (101)<sub>b</sub> (3 first bits of anticollision Prefix byte) the PICC shall not answer to any command frame not starting with (101)<sub>b</sub> ;
- the PICC shall only react to valid frames received (no response sent when transmission errors are detected).

#### 7.4.3 POWER-OFF state

##### Description :

In the POWER-OFF State, the PICC is not powered due to a lack of carrier energy.

##### State exit conditions and transitions :

If the PICC is in an energizing magnetic field greater than H<sub>min</sub> (see ISO/IEC 14443-2), it shall enter its IDLE state within a delay not greater than defined in clause 5.

#### 7.4.4 IDLE state

##### Description :

In the IDLE state, the PICC is powered. It listens for frames and shall recognize REQB and WUPB messages.

##### State exit conditions and transitions :

On reception of a valid REQB or WUPB Command frames the PICC moves onto the READY REQUESTED sub-state. (Valid REQB/WUPB means valid frame with REQB/WUPB Command and matched AFI. See REQB/WUPB Command specification for more details).

#### 7.4.5 READY-REQUESTED sub-state

##### Description :

In the READY-REQUESTED sub-state, the PICC is powered and has received a valid REQB or WUPB Commands with a control parameter N. The PICC calculate a random number R which is used to control its subsequent operation as described in clause 7.6.

##### State exit conditions and transitions :

See 7.6.for details.



#### 7.4.6 READY-DECLARED sub-state

##### Description :

In the READY-DECLARED state, the PICC is powered and has sent its ATQB corresponding to the last valid REQ/WUPB message received.

It listens to frames and shall recognize REQ/WUPB, ATTRIB and HLTB commands.

##### State exit conditions and transitions :

On reception of a valid ATTRIB Command the PICC shall enter the ACTIVE state if the PUPI in the ATTRIB Command matches the PICC PUPI.

If the PUPI in the ATTRIB Command does not match the PICC PUPI the PICC remains in the READY-DECLARED state.

On reception of a valid REQ/WUPB Command frame the same conditions and transitions apply as on reception of a valid REQ/WUPB Command frame in the IDLE state.

On reception of a matched HLTB Command the PICC shall enter the HALT state.

#### 7.4.7 ACTIVE state

##### Description :

The PICC is powered and has entered a higher layer mode since a Card Identifier (CID) has been assigned to this PICC through the ATTRIB Command.

The PICC listens to any higher layer message properly formatted (proper CID and valid CRC<sub>B</sub>).

The PICC shall not emit subcarrier following any frame with invalid CRC<sub>B</sub> or with another CID than the one assigned.

##### State exit conditions and transitions :

The PICC enters the HALT state when a valid DESELECT Command frame is received (DESELECT Command is defined in ISO/IEC 14443-4).

##### Specific remarks :

Valid REQ/WUPB or Slot-MARKER frames shall not be answered.

A valid frame with an ATTRIB Command shall not be answered.

In the higher layer protocol, specific commands may be defined to return the PICC to other states (IDLE or HALT). The PICC may return to these states only following reception of such commands.

#### 7.4.8 HALT state

##### Description :

The PICC shall respond only to a WUPB Command which brings it back to the idle state.

##### State exit conditions and transitions :

The PICC returns to the POWER\_OFF state if the RF field disappears.

### 7.5 Command set

Four primitive commands are used to manage multi-node communication channels :

- REQB/WUPB ;
- Slot-MARKER ;
- ATTRIB ;
- HLTB.

All four commands use the character, frame format and timing detailed in clause 7.1.

The commands and the responses of the PICC to these commands are described in the following sections.

Any frame received with a wrong format (wrong frame identifiers or invalid CRC\_B) shall be ignored.

### 7.6 Anticollision response rules

A PICC which is in the READY-REQUESTED sub-state, after receiving a valid REQB/WUPB Command (Requested AFI=0 or AFI matched with an internal application), shall respond according to the following rules, where the parameter N has been given in the REQB/WUPB Command :

If N = 1 the PICC shall send an ATQB and shall move to the READY-DECLARED sub-state

If N > 1 the PICC shall internally generate a random number R which shall be evenly distributed between 1 to N

If R = 1 the PICC shall send an ATQB and shall move to the READY-DECLARED sub-state.

If R > 1 :

- PICCs employing the probabilistic approach (informative option 1) shall return to IDLE state ;
- PICCs employing the slot marker approach (informative option 2) shall wait until they have received a Slot-MARKER Command with a matched slot number (slot number = R) before sending the ATQB and moving to the READY-DECLARED sub-state.

### 7.7 REQB/WUPB Command

The REQB and WUPB Commands sent by the PCD are used to probe the field for PICCs of Type B.

In addition WUPB is particularly used to also wake up PICCs which are in HALT state.

The number of slots N is included in the command as a parameter to optimize the anti-collision algorithm for a given application. See Figure 19 for detailed description of when the PICC shall respond to these respective commands.

#### 7.7.1 REQB/WUPB Command format

REQB/WUPB Command has the following format :

1 <sup>st</sup> byte	2 <sup>nd</sup> byte	3 <sup>rd</sup> byte	4 <sup>th</sup> , 5 <sup>th</sup> bytes
<b>APf</b> (1 byte)	<b>AFI</b> (1 byte)	<b>PARAM</b> (1 byte).	<b>CRC_B</b> (2 bytes)
MSB	LSB MSB	LSB MSB	LSB MSB

Figure 20 — REQB/WUPB Command format

**7.7.2 Coding of Anticollision Prefix byte APf**

The Anticollision Prefix byte is APf = '05' = (0000 0101)<sub>b</sub>.

**7.7.3 Coding of AFI**

AFI (Application Family Identifier) represents the type of application targeted by the PCD and is used to preselect PICCs before the ATQB. Only PICCs with applications of the type indicated by the AFI may answer to a REQB/WUPB Command with AFI different to '00'.

When AFI equals '00', all PICCs shall process the REQB/WUPB.

The most significant half byte of AFI is used to code one specific or all application families, as defined in Table 12.

The least significant half byte of AFI is used to code one specific or all application sub-families. Sub-family codes different from 0 are proprietary.

**Table 12 — AFI coding**

AFI Most Significant half byte	AFI Least Significant half byte	Meaning – PICCs respond from	Examples / Note
'0'	'0'	All families and sub-families	No application preselection
X	'0'	All sub-families of family X	Wide application preselection
X	Y	Only the Yth sub-family of family X	
'0'	Y	Proprietary sub-family Y only	
'1'	'0', Y	Transport	Mass transit, Bus, Airline,...
'2'	'0', Y	Financial	IEP, Banking, Retail,...
'3'	'0', Y	Identification	Access Control,...
'4'	'0', Y	Telecommunication	Public Telephony, GSM,...
'5'	'0', Y	Medical	
'6'	'0', Y	Multimedia	Internet services....
'7'	'0', Y	Gaming	
'8'	'0', Y	Data Storage	Portable Files, ...
'9'-'F'	'0', Y	RFU	

NOTE X = '1' to 'F', Y = '1' to 'F'

**7.7.4 Coding of PARAM**

b8	b7	b6	b5	b4	b3	b2	b1
RFU				REQB / WUPB	N (Number of slots)		

All RFU bits shall be set to 0

**Figure 21 — Coding of PARAM**

b4 = 0 defines REQB : PICCs in Idle state or Ready state shall process this command  
 b4 = 1 defines WUPB : PICCs in Idle state or Ready state or HALT state shall process this command  
 b1, b2 and b3 are used to code the number of slots N according to Table 13.

**Table 13 — Coding of N**

b3	b2	b1	N
0	0	0	1 = 2 <sup>0</sup>
0	0	1	2 = 2 <sup>1</sup>
0	1	0	4 = 2 <sup>2</sup>
0	1	1	8 = 2 <sup>3</sup>
1	0	0	16 = 2 <sup>4</sup>
1	0	1	RFU
1	1	x	RFU

NOTE For each PICC, the probability of response (ATQB) in the first slot is 1/N. Thus, if the probabilistic approach is used in the PCD, N is not used to adjust the number of slots but the probability for the PICC to return its ATQB in this unique slot.

**7.8 Slot-MARKER Command**

After a REQB/WUPB Command, the PCD may send up to (N-1) Slot-MARKER Commands to define the start of each timeslot.

Slot-MARKER Commands can be sent :

- after the end of an ATQB message received by the PCD to mark the start of the next slot ;
- or earlier if no ATQB is received (no need to wait until the end of a slot, if this slot is known to be empty).

It is not mandatory for a PICC to support this command. In this case, the PICC shall ignore any Slot-MARKER Command. The PICC may only send its ATQB after REQB (in the first slot) in a probabilistic approach.

**7.8.1 Slot-MARKER Command format**

Slot-MARKER Command has the following format :

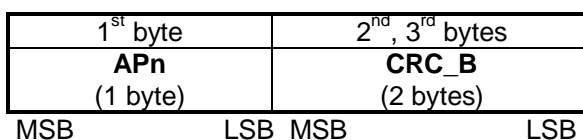

**Figure 22 — Slot-MARKER Command format**

**7.8.2 Coding of Anticollision Prefix byte APn**

APn = (nnnn 0101)b where nnnn codes the slot number as defined in the Table 14.

**Table 14 — Coding of slot number**

nnnn	Slot number
0001	2
0010	3
0011	4
.....	.....
1110	15
1111	16

NOTE It is not mandatory that the Slot-MARKER Commands are sent sequentially with incremental slot numbers.

## 7.9 ATQB Response

The response to both REQW/WUPB and Slot-MARKER Commands is named ATQB.

### 7.9.1 ATQB Response format

ATQB Response has the following format :

1 <sup>st</sup> byte	2 <sup>nd</sup> , 3 <sup>rd</sup> , 4 <sup>th</sup> , 5 <sup>th</sup> bytes	6 <sup>th</sup> , 7 <sup>th</sup> , 8 <sup>th</sup> , 9 <sup>th</sup> , bytes	10 <sup>th</sup> , 11 <sup>th</sup> , 12 <sup>th</sup> , bytes	13 <sup>th</sup> , 14 <sup>th</sup> bytes
'50' (1 byte)	<b>PUPI</b> (4 bytes)	<b>Application Data</b> (4 bytes)	<b>Protocol Info</b> (3 bytes)	<b>CRC_B</b> (2 bytes)
MSB LSB	MSB LSB	MSB LSB	MSB LSB	MSB LSB

Figure 23 — ATQB Response format

### 7.9.2 PUPI (Pseudo-Unique PICC Identifier)

A Pseudo-Unique PICC Identifier (PUPI) is used to differentiate PICCs during anticollision. This 4-byte number may be either a number dynamically generated by the PICC or a diversified fixed number. The PUPI may only change in the idle state.

### 7.9.3 Application Data

The Application data field is used to inform the PCD which applications are currently installed in the PICC. This information allows the PCD to select the desired PICC in the presence of more than one PICC.

The application data is defined dependent upon the ADC (Application Data Coding) field in the Protocol Info (see 7.9.4.), which defines if either the CRC\_B compressing method described below or proprietary coding is used.

When the CRC\_B compressing coding is used, Application Data field contains the following :

1 <sup>st</sup> byte	2 <sup>nd</sup> , 3 <sup>rd</sup> bytes	4 <sup>th</sup> byte
AFI (1 byte)	CRC_B(AID) (2 bytes)	Numbers of Applications (1 byte)
MSB LSB	MSB LSB	MSB LSB

Figure 24 — Application Data format

#### 7.9.3.1 AFI

For mono application PICCs AFI gives the family of the application (see AFI coding in Table 12).

For multi application PICCs AFI gives the family of the application described in CRC\_B(AID).

#### 7.9.3.2 CRC\_B(AID)

CRC\_B(AID) is the result of calculation of CRC\_B of the AID (as defined in ISO/IEC 7816-5) of an application in the PICC matching the AFI given in the REQW/WUPB Command.

#### 7.9.3.3 Numbers of Applications

Indicates on presence of other applications in the PICC.

The most significant half byte value gives the number of applications corresponding to the AFI given in Application Data with '0' meaning no application and 'F' meaning 15 applications or more.

The least significant half byte value gives the total number of applications in the PICC with '0' meaning no application and 'F' meaning 15 applications or more.

**7.9.4 Protocol Info**

The Protocol Info field indicates the parameters supported by the PICC. It is formatted as detailed below.

1 <sup>st</sup> byte		2 <sup>nd</sup> byte		3 <sup>rd</sup> byte	
<b>Bit_Rate_capability</b> (8 bits)	<b>Max_Frame_Size</b> (4 bits)	<b>Protocol_Type</b> (4 bits)	<b>FWI</b> (4 bits)	<b>ADC</b> (2 bits)	<b>FO</b> (2 bit)
MSB	LSB	MSB	LSB	MSB	LSB

**Figure 25 — Protocol Info format**

**7.9.4.1 FO**

**Table 15 — Frame Option supported by the PICC**

b2	b1	Meaning
1	x	NAD supported by the PICC
x	1	CID supported by the PICC

**7.9.4.2 ADC**

**Table 16 — Application Data Coding supported by the PICC**

b4	b3	Meaning
0	0	Application is proprietary
0	1	Application is coded as described in clause 7.9.3.
Other values are RFU		

**7.9.4.3 FWI**

Frame Waiting time Integer (4 bits) :

FWI codes an integer value used to define the FWT.

The FWT defines the maximum time for a PICC to start its response after the end of a PCD frame.

FWT is calculated by the formula :

$$FWT = (256 \times 16/fc) \times 2^{FWI}$$

where the value of FWI has the range from 0 to 14 and the value of 15 is RFU.

For FWI = 0, FWT is minimal (~ 302 μs) ;

For FWI = 14, FWT is maximal (~ 4949 ms).

7.9.4.4 Protocol\_Type

Table 17 — Protocol Types supported by the PICC

b4	b3	b2	b1	Meaning
0	0	0	1	PICC compliant with ISO/IEC 14443-4
0	0	0	0	PICC not compliant with ISO/IEC 14443-4
Other values are RFU.				

7.9.4.5 Max\_Frame\_Size

Table 18 — Maximum frame size

Maximum Frame Size Code in ATQB	0	1	2	3	4	5	6	7	8	9-F
Maximum Frame Size (bytes)	16	24	32	40	48	64	96	128	256	RFU > 256

7.9.4.6 Bit\_Rate\_capability

Table 19 — Bit rates supported by the PICC

b8	b7	b6	b5	b4	b3	b2	b1	Meaning
0	0	0	0	0	0	0	0	PICC supports only 106 kbit/s in both directions
1	x	x	x	0	x	x	x	Same bit rate from PCD to PICC and from PICC to PCD compulsory
x	x	x	1	0	x	x	x	PICC to PCD, 1etu = 64 / fc, bit rate supported is 212 kbit/s
x	x	1	x	0	x	x	x	PICC to PCD, 1etu = 32 / fc, bit rate supported is 424 kbit/s
x	1	x	x	0	x	x	x	PICC to PCD, 1etu = 16 / fc, bit rate supported is 847 kbit/s
x	x	x	x	0	x	x	1	PCD to PICC, 1etu = 64 / fc, bit rate supported is 212 kbit/s
x	x	x	x	0	x	1	x	PCD to PICC, 1etu = 32 / fc, bit rate supported is 424 kbit/s
x	x	x	x	0	1	x	x	PCD to PICC, 1etu = 16 / fc, bit rate supported is 847 kbit/s
Other values (with b4 = 1) are RFU.								

7.10 ATTRIB Command

The ATTRIB Command sent by the PCD shall include information required to select a single PICC.

A PICC receiving an ATTRIB Command with its identifier becomes selected and assigned to a dedicated channel. After being selected, this PICC only responds to commands defined in ISO/IEC 14443-4 which include its unique CID.

7.10.1 ATTRIB Command format

ATTRIB Command has the following format :

1 <sup>st</sup> byte	2 <sup>nd</sup> , 3 <sup>rd</sup> , 4 <sup>th</sup> , 5 <sup>th</sup> bytes	6 <sup>th</sup> byte	7 <sup>th</sup> byte	8 <sup>th</sup> byte	9 <sup>th</sup> byte	10 <sup>th</sup> , .....bytes	
'1D' (1 byte)	Identifier (4 bytes)	Param 1 (1 byte)	Param 2 (1 byte)	Param 3 (1 byte)	Param 4 (1 byte)	Higher layer - INF (optional – 0 or more bytes)	CRC_B (2 bytes)
MSB LSB	MSB LSB	MSB LSB	MSB LSB	MSB LSB	MSB LSB	MSB LSB	MSB LSB

Figure 26 — ATTRIB Command format

**7.10.2 Identifier**

This identifier is the value of the PUPI sent by the PICC in the ATQB.

**7.10.3 Coding of Param 1**

b8	b7	b6	b5	b4	b3	b2	b1
Minimum TR0		Minimum TR1		EOF	SOF	RFU	

All RFU bits shall be set to 0 if not otherwise specified

**Figure 27 — Coding of Param 1**

**7.10.3.1 Minimum TR0**

Minimum TR0 indicates to the PICC the minimum delay before responding after the end of a command sent by a PCD. The default value has been defined in ISO/IEC 14443-2 clause 9.2.5.

**Table 20 — Minimum TR0 coding**

b8	b7	Minimum TR0
0	0	default value
0	1	48/fs
1	0	16/fs
1	1	RFU

NOTE Minimum TR0 is required by the PCD when switching from transmit to receive and its value depends on the PCD performance.

**7.10.3.2 Minimum TR1**

Minimum TR1 indicates to the PICC the minimum delay between subcarrier modulation start and beginning of data transmission. The default value has been defined in ISO/IEC 14443-2 clause 9.2.5.

**Table 21 — Minimum TR1 coding**

b6	b5	Minimum TR1
0	0	default value
0	1	64/fs
1	0	16/fs
1	1	RFU

NOTE Minimum TR1 is required by the PCD for synchronization with the PICC and its value depends on the PCD performance.



### 7.10.3.3 EOF/SOF

b3 and b4 indicate the PCD capability to support suppression of the EOF and/or SOF from PICC to PCD, which may reduce communication overhead. The suppression of EOF and/or SOF is optional for the PICC. The coding of b3 and b4 is as follows :

**Table 22 — SOF handling**

b3	SOF required
0	Yes
1	No

**Table 23 — EOF handling**

b4	EOF required
0	Yes
1	No

### 7.10.4 Coding of Param 2

The least significant half byte (b4 to b1) is used to code the maximum frame size that can be received by the PCD as specified in Table 24.

**Table 24 — Coding of b4 to b1 of Param 2**

Maximum Frame Size Code in ATTRIB	0	1	2	3	4	5	6	7	8	9-F
Maximum Frame Size (bytes)	16	24	32	40	48	64	96	128	256	RFU > 256

The most significant half byte (b8 to b5) is used for bit rate selection, as specified in Tables 25 and 26.

**Table 25 — Coding of b6 & b5 of Param 2**

b6	b5	Meaning
0	0	PCD to PICC, 1etu = 128 / fc, bit rate is 106 kbit/s
0	1	PCD to PICC, 1etu = 64 / fc, bit rate is 212 kbit/s
1	0	PCD to PICC, 1etu = 32 / fc, bit rate is 424 kbit/s
1	1	PCD to PICC, 1etu = 16 / fc, bit rate is 847 kbit/s

**Table 26 — Coding of b8 & b7 of Param 2**

b8	b7	Meaning
0	0	PICC to PCD, 1etu = 128 / fc, bit rate is 106 kbit/s
0	1	PICC to PCD, 1etu = 64 / fc, bit rate is 212 kbit/s
1	0	PICC to PCD, 1etu = 32 / fc, bit rate is 424 kbit/s
1	1	PICC to PCD, 1etu = 16 / fc, bit rate is 847 kbit/s

### 7.10.5 Coding of Param 3

The least significant half byte (b4 to b1) is used for confirmation of the protocol type as specified in Table 17.

The most significant half byte (b8 to b5) is set to (0000)b, all other values are RFU.

**7.10.6 Coding of Param 4**

The Param 4 byte consists of two parts :

- the least significant half byte (b4 to b1) is named Card Identifier (CID) and defines the logical number of the addressed PICC in the range from 0 to 14. The value 15 is RFU. The CID is specified by the PCD and shall be unique for each active PICC. If the PICC does not support CID, code value (0000)b shall be used ;
- the most significant half byte (b8 to b5) is set to (0000)b, all other values are RFU.

**7.10.7 Higher layer INF**

Any higher layer command transferable as the INF field of ISO/IEC 14443-4 may be included.

It is not mandatory for the PICC to process successfully any command in this context.

The PICC shall however process successfully such message if no application command is included.

**7.11 Answer to ATTRIB Command**

The PICC shall answer to any valid ATTRIB Command (correct PUPI and valid CRC\_B) with the format described below.

1 <sup>st</sup> byte		2 <sup>nd</sup> .....bytes			
MBLI	CID	Higher layer Response		CRC_B	
(1 byte)		(optional 0 or more bytes)			
MSB	LSB	MSB	LSB	MSB	LSB

**Figure 28 — Format of the Answer to an ATTRIB Command**

The first byte consists of two parts :

- the least significant half byte (b4 to b1) contains the returned CID. If the PICC does not support CID, code value (0000)b is returned ;
- the most significant half byte (b8 to b5) is called the Maximum Buffer Length Index (MBLI). It is used by the PICC to let the PCD know the limit of its internal buffer to received chained frames. The coding of MBLI is as follows :
  - MBLI = 0 means that the PICC provides no information on its internal input buffer size ;
  - MBLI > 0 is used to calculate the actual internal maximum buffer length (MBL) according to the following formula :  $MBL = (\text{PICC Maximum Frame Size}) * 2^{(MBLI-1)}$  where the PICC maximum frame size is returned by the PICC in its ATQB. When it send chained frames to a PICC, the PCD shall ensure that the accumulated length is never greater than MBL.

Remaining bytes are optional and used for higher layer response.

As illustrated below, a PICC shall answer the empty (no higher layer INF field) ATTRIB Command with an empty higher layer response :

1 <sup>st</sup> byte		2 <sup>nd</sup> , 3 <sup>rd</sup> bytes	
<b>MBLI</b>	<b>CID</b>	<b>CRC_B</b>	
(1 byte)		(2 bytes)	
MSB	LSB	MSB	LSB

**Figure 29 — PICC Answer to ATTRIB format without higher layer response**

NOTE 1 A valid Answer (same CID and valid CRC\_B) to an ATTRIB Command (as defined in Figure 28 or 29) is the means for a PCD to verify that PICC selection has been successful.

NOTE 2 Higher layer response indicating that the higher layer command is not supported by the PICC within this context is allowed as long as the PICC response meets the format described above.

**7.12 HLTB Command and Answer**

The HLTB Command is used to set a PICC in HALT state and stop responding to a REQb.

After answering to this command the PICC shall ignore any commands except the WUPB Command (see 7.7)

HLTB Command has the following format :

1 <sup>st</sup> byte		2 <sup>nd</sup> , 3 <sup>rd</sup> , 4 <sup>th</sup> , 5 <sup>th</sup> bytes		6 <sup>th</sup> , 7 <sup>th</sup> bytes	
<b>'50'</b>		<b>Identifier</b>		<b>CRC_B</b>	
(1 byte)		(4 bytes)		(2 bytes)	
MSB	LSB	MSB	LSB	MSB	LSB

**Figure 30 — Format of the HLTB Command**

The 4 bytes identifier is the value of the PUPI sent by the PICC in the ATQB.

The format of Answer to a HLTB Command from the PICC is as follows :

1 <sup>st</sup> byte		2 <sup>nd</sup> , 3 <sup>rd</sup> bytes	
<b>'00'</b>		<b>CRC_B</b>	
(1 byte)		(2 bytes)	
MSB	LSB	MSB	LSB

**Figure 31 — Format of PICC Answer to HLTB Command**

## Annex A (informative)

### Communication example Type A

This example shows the select sequence with 2 PICCs in the field on the assumption of :

- PICC #1 with UID size : single, value of uid0 is '10' ;
- PICC #2 with UID size : double.

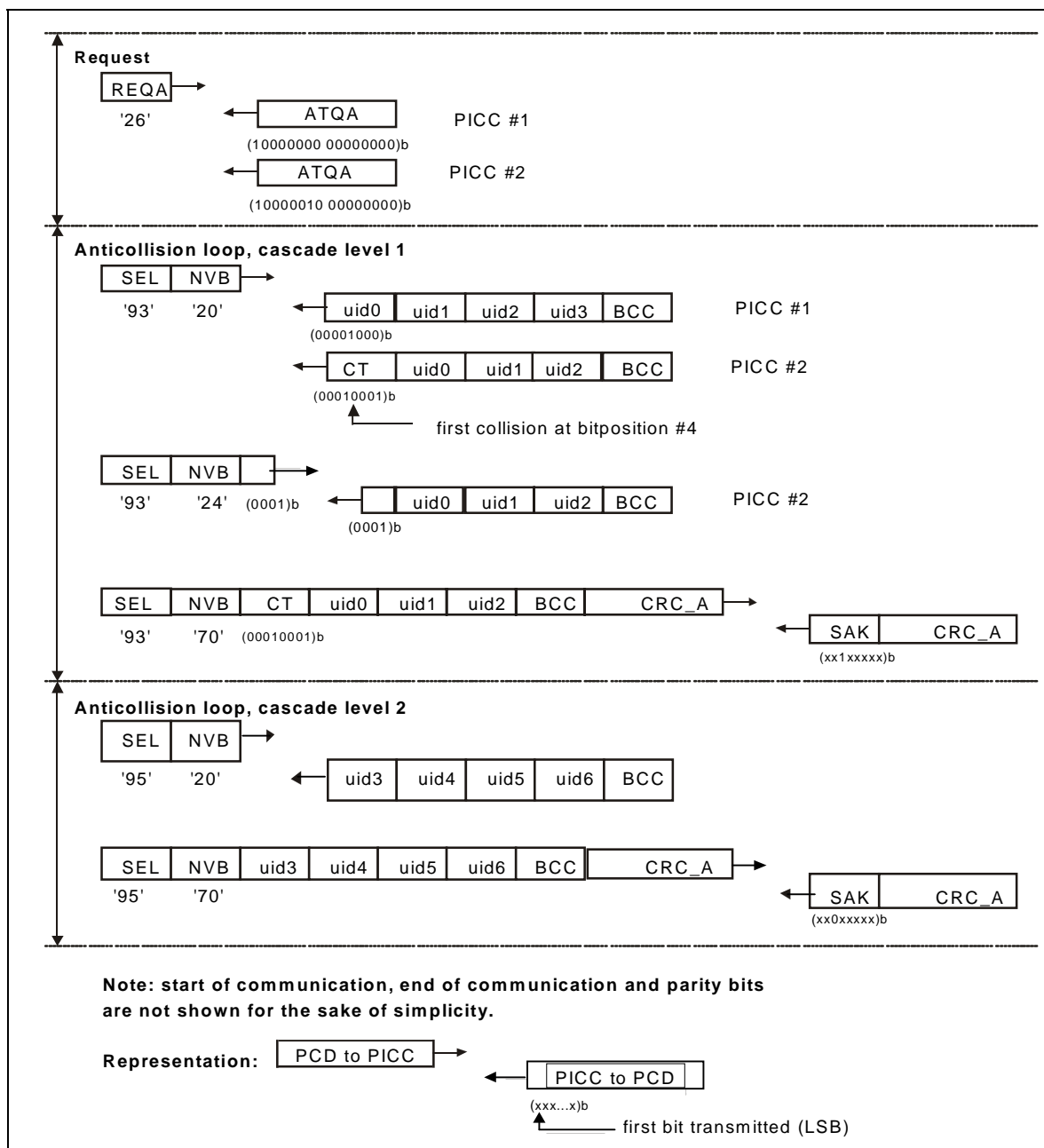

**Figure A.1 —Select sequence with bit frame anticollision**

## Explanations to Figure A1 :

Request	<ul style="list-style-type: none"> <li>— PCD transmits the REQA Command</li> <li>— All PICCs respond with their ATQA : <ul style="list-style-type: none"> <li>— PICC #1 indicates bit frame anticollision and UID size : single ;</li> <li>— PICC #2 indicates bit frame anticollision and UID size : double.</li> </ul> </li> </ul>
Anticollision loop, cascade level 1	<ul style="list-style-type: none"> <li>— PCD transmits an ANTICOLLISION Command :</li> <li>— SEL specifies bit frame anticollision and cascade level 1 ;</li> <li>— the value '20' of NVB specifies that the PCD will transmit no part of UID CL1 ;</li> <li>— consequently all PICCs in the field respond with their complete UID CL1 ;</li> <li>— due to the value '88' of the cascade tag, the first collision occurs at bit position #4 ;</li> <li>— PCD transmits another ANTICOLLISION Command that includes the first 3 bits of UID CL1 that were received before the collision occurs, followed by a (1)b. Consequently the PCD assigns NVB with the value '24' ;</li> <li>— these 4 bits correspond to the first bits of UID CL1 of PICC #2 ;</li> <li>— PICC #2 responds with its 36 remaining bits of UID CL1. Since PICC #1 does not respond, no collision occurs ;</li> <li>— since the PCD "knows" all bits of UID CL1 of PICC #2, it transmits a SELECT Command for PICC #2 ;</li> <li>— PICC #2 responds with SAK, indicating that UID is not complete ;</li> <li>— consequently, the PCD increases the cascade level.</li> </ul>
Anticollision loop, cascade level 2	<ul style="list-style-type: none"> <li>— PCD transmits another ANTICOLLISION Command :</li> <li>— SEL specifies bit frame anticollision and cascade level 2 ;</li> <li>— NVB is reset to '20' to force PICC #2 to respond with its complete UID CL2 ;</li> <li>— PICC #2 responds with all 40 bits of its UID CL2 ;</li> <li>— PCD transmits the SELECT Command for PICC #2, cascade level 2 ;</li> <li>— PICC #2 responds with SAK, indicating that UID is complete, and transits from READY State to ACTIVE State.</li> </ul>

## Annex B (informative)

### CRC\_A and CRC\_B encoding

#### CRC\_A encoding

This annex is provided for explanatory purposes and indicates the bit patterns that will exist in the physical layer. It is included for the purpose of checking an ISO/IEC 14443-3 Type A implementation of CRC\_A encoding.

The process of encoding and decoding may be conveniently carried out by a 16-stage cyclic shift register with appropriate feedback gates. According to ITU-T Recommendation V.41, ANNEX I, figures I-1/V.41 and I-2/V.41 the flip-flops of the register shall be numbered from FF0 to FF15. FF0 shall be the leftmost flip-flop where data is shifted in. FF15 shall be the rightmost flip-flop where data is shifted out.

Table B1 defines the initial content of the register.

**Table B.1 — Initial content of 16-stage shift register according to value '6363'**

FF0	FF1	FF2	FF3	FF4	FF5	FF6	FF7	FF8	FF9	FF10	FF11	FF12	FF13	FF14	FF15
0	1	1	0	0	0	1	1	0	1	1	0	0	0	1	1

Consequently, FF0 corresponds to the MSB and FF15 to the LSB.

#### Examples of bit patterns that will be transmitted via standard frames

EXAMPLE 1 Transmission of data, first byte = '00', second byte = '00', CRC\_A appended.

Calculated CRC\_A = '1EA0'

First bit transmitted

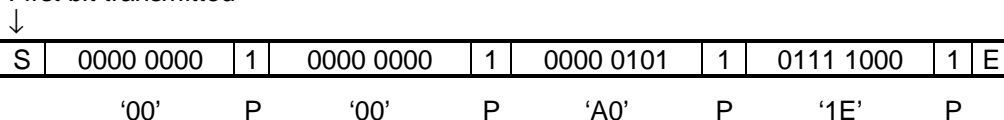

**Figure B.1 — Example 1 for CRC\_A encoding**

**Table B.2 — Content of 16-stage shift register according to value '1EA0'**

FF0	FF1	FF2	FF3	FF4	FF5	FF6	FF7	FF8	FF9	FF10	FF11	FF12	FF13	FF14	FF15
0	0	0	1	1	1	1	0	1	0	1	0	0	0	0	0

EXAMPLE 2 Transmission of data block, first byte = '12', second byte = '34', CRC\_A appended.

Calculated CRC\_A = 'CF26'

First bit transmitted

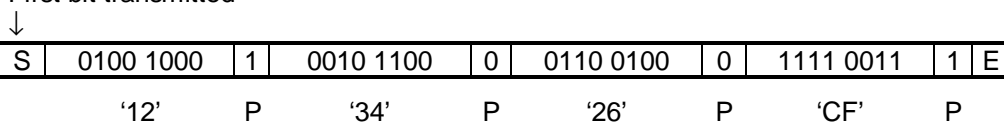

**Figure B.2 — Example 2 for CRC\_A encoding**

**Table B.3 — Content of 16-stage shift register according to value 'CF26'**

FF0	FF1	FF2	FF3	FF4	FF5	FF6	FF7	FF8	FF9	FF10	FF11	FF12	FF13	FF14	FF15
1	1	0	0	1	1	1	1	0	0	1	0	0	1	1	0

**CRC\_B encoding**

This annex is provided for explanatory purposes and indicates the bit patterns that will exist in the physical layer. It is included for the purpose of checking an ISO/IEC 14443-3 Type B implementation of CRC\_B encoding. Refer to ISO/IEC 13239 and CCITT X.25 #2.2.7 and V.42 #8.1.1.6.1 for further details.

Initial Value = 'FFFF'

**Examples of bit patterns that will be transmitted via standard frames**

EXAMPLE 1 Transmission of first byte = '00', second byte = '00', third byte = '00', CRC\_B appended.

Calculated CRC\_B = 'C6CC'

		<b>1st byte</b>	<b>2nd byte</b>	<b>3rd byte</b>	<b>CRC_B</b>		
Frame =	SOF	'00'	'00'	'00'	'CC'	'C6'	EOF

**Figure B.3 — Example 1 for CRC\_B encoding**

EXAMPLE 2 Transmission of first byte = '0F', second byte = 'AA', third byte = 'FF', CRC\_B appended.

Calculated CRC\_B = 'D1FC'

		<b>1st byte</b>	<b>2nd byte</b>	<b>3rd byte</b>	<b>CRC_B</b>		
Frame =	SOF	'0F'	'AA'	'FF'	'FC'	'D1'	EOF

**Figure B.4 — Example 2 for CRC\_B encoding**

EXAMPLE 3 Transmission of first byte = '0A', second byte = '12', third byte = '34', fourth byte = '56', CRC\_B appended.

Calculated CRC\_B = 'F62C'

		<b>1st byte</b>	<b>2nd byte</b>	<b>3rd byte</b>	<b>4th byte</b>	<b>CRC_B</b>		
Frame =	SOF	'0A'	'12'	'34'	'56'	'2C'	'F6'	EOF

**Figure B.5 — Example 3 for CRC\_B encoding**

Code sample written in C language for CRC calculation

```

#include <stdio.h>
#include <stdlib.h>
#include <string.h>
#include <ctype.h>

#define CRC_A 1
#define CRC_B 2
#define BYTE unsigned char

unsigned short UpdateCrc(unsigned char ch, unsigned short *lpwCrc)
{
    ch = (ch^(unsigned char)((*lpwCrc) & 0x00FF));

    ch = (ch^(ch<<4));

    *lpwCrc = (*lpwCrc >> 8)^((unsigned short)ch << 8)^((unsigned short)ch<<3)^((unsigned short)ch>>4);

    return(*lpwCrc);
}

void ComputeCrc(int CRCType, char *Data, int Length,
    BYTE *TransmitFirst, BYTE *TransmitSecond)
{
    unsigned char chBlock;
    unsigned short wCrc;

    switch(CRCType) {
        case CRC_A:
            wCrc = 0x6363; /* ITU-V.41 */
            break;
        case CRC_B:
            wCrc = 0xFFFF; /* ISO/IEC 13239 (formerly ISO/IEC 3309) */
            break;
        default:
            return;
    }

    do {
        chBlock = *Data++;
        UpdateCrc(chBlock, &wCrc);
    } while (--Length);
    if (CRCType == CRC_B)
        wCrc = ~wCrc; /* ISO/IEC 13239 (formerly ISO/IEC 3309) */

    *TransmitFirst = (BYTE) (wCrc & 0xFF);
    *TransmitSecond = (BYTE) ((wCrc >> 8) & 0xFF);

    return;
}

BYTE BuffCRC_A[10] = {0x12, 0x34};
BYTE BuffCRC_B[10] = {0x0A, 0x12, 0x34, 0x56};
unsigned short Crc;
BYTE First, Second;
FILE *OutFd;
int i;

```



```
int main(void)
{
    printf("CRC-16 reference results ISO/IEC 14443-3\n");
    printf("Crc-16 G(x) = x^16 + x^12 + x^5 + 1\n\n");
    printf("CRC_A of [ ");
    for(i=0; i<2; i++) printf("%02X ",BuffCRC_A[i]);
    ComputeCrc(CRC_A, BuffCRC_A, 2, &First, &Second);
    printf("] Transmitted: %02X then %02X.\n", First, Second);
    printf("CRC_B of [ ");
    for(i=0; i<4; i++) printf("%02X ",BuffCRC_B[i]);
    ComputeCrc(CRC_B, BuffCRC_B, 4, &First, &Second);
    printf("] Transmitted: %02X then %02X.\n", First, Second);

    return(0);
}
```

## Annex C (informative)

### Type A timeslot – Initialization and anticollision

This annex describes the timeslot detection protocol applicable for PICCs of Type A. A PCD supporting Polling for both of Type A and Type B is not required to support this detection protocol as a mandatory anticollision protocol as described in clause 5.

#### C.1. Terms and abbreviations

The following are specific to this section of ISO/IEC 14443-3.

ATQA_t	Answer To reQuest of Type A_timeslot
ATQ-ID	Answer To REQ-ID
CID_t	Card IDentifier of Type A_timeslot
HLTA_t	HALT Command of Type A_timeslot
REQA_t	REQuest Command of Type A_timeslot
REQ-ID	REQuest-ID Command
SAK_t	Select AKnowledge of Type A_timeslot
SEL_t	SElect Command of Type A_timeslot

#### C.2. Timing and frame format

##### C.2.1. Timing definitions

###### Polling reset time

Polling reset times of Type A\_timeslot are equal to those of Type A in clause 5.

###### Time interval from REQA\_t to ATQA\_t

PICC returns ATQA\_t after waiting for  $32 \pm 2$  etu upon receiving REQA\_t. The PCD may not recognize the coding of the ATQA\_t.

###### Request Guard Time

The Request Guard Time is defined as the minimum time between the start of bits of two consecutive Request commands. Its value shall be 0,5 ms.

###### Frame Guard Time

The Frame Guard Time is defined as the minimum time between the rising edge of the last bit and the falling edge of the start bit of two consecutive frames in opposite direction. Its value shall be 10 etu.

###### Timeslot length

The first timeslot starts in 32 etu after REQ-ID. Each timeslot length is 104 etu consisting of 94 etu for ATQ-ID reception and 10 etu frame guard time succeeding.

##### C.2.2. Frame formats

###### REQA\_t frame

See 6.1.5.1 and table 2. The data content is '35' for a REQA\_t.

###### Standard frame

The LSB of each byte is transmitted first. Each byte has no parity. CRC\_B is defined in subclause 7.2.

S	data: n *(8 data bits +no parity)				CRC_B 2 bytes	E
	1byte command or response	(0 or 1byte) (parameter 1)	(0 or 1 byte) (parameter 2)	(0 or 8 bytes) (UID)		

**C.3. PICC states**

The following clauses provide the states for a PICC, Type A\_timeslot.

**POWER-OFF state**

In the POWER-OFF state, the PICC is not energized due to lack of carrier and shall not emit subcarrier.

**IDLE state**

This state is entered after the field has been active within a 5 ms delay. The PICC recognizes REQA\_t.

**READY state**

This state is entered by REQA\_t. The PICC recognizes REQA\_t, REQ-ID and SEL\_t.

**ACTIVE state**

This state has two substates. The first sub-state is entered by SEL\_t with its complete UID and CID\_t. In this sub-state, the PICC recognizes HLTA\_t and proprietary higher layer commands. The second substate is in ISO/IEC 14443-4 and entered from the first sub-state by a command defined in ISO/IEC 14443-4.

**HALT state**

This state is entered by HLTA\_t from ACTIVE State. In this state, the PICC is mute.

**C.4. Command/response set**

Four sets of command and response are used.

Type	Name	Coding (b8-b1)	Meaning
command	REQA_t	(b7-b1) (0110101)b (=‘35’)	Request PICC Type A timeslot to answer ATQA_t..
Response	ATQA_t	any one-byte content of ‘00’ to ‘FF’	Answer to REQA_t. PCD can recognize the existence of Type A timeslot PICC. However, the PCD is not required to recognize the coding of the ATQA_t.
command	REQ-ID	(00001000)b (= ‘08’)	Request the PICC to answer its UID to one of timeslots. REQ-ID is followed by two parameters.
Response	ATQ-ID	(00000110)b (= ‘06’)	Answer 8-byte UID to one of 4 timeslots. ATQ-ID is followed by its 8-byte UID.
command	SEL_t	(01000NNN)b, (NNN=CID_t No.(0-7)) (01100NNN)b, (NNN+8=CID_t No.(8-15))	Select the PICC with its UID and set the CID_t. SEL_t is followed by 8-byte UID.
Response	SAK_t	b8-b5 (1000)b: Additional information available in protocols b8-b5 (1100)b: Default mode in protocols b4-b1(0000)b: Other than ISO/IEC 14443-4 b4-b1(0001)b: PICC supports ISO/IEC 14443-4	Acknowledge SEL_t
command	HLTA_t	(00011NNN)b, (NNN=CID_t No.(0-7)) (00111NNN)b, (NNN+8=CID_t No.(8-15))	Halt the PICC with its CID_t
Response	Answer to HLTA_t	(00000110)b (= ‘06’)	Acknowledge HLTA_t

Parameters of REQ-ID Command

Parameters	Meaning	
P1	b8-b7	Timeslot length, b7=1: for 8-byte UID, b8=0
	b6-b1	Number of timeslots, .b3=1:for 4 timeslots, Others=0
P2		'00'

C.5. Timeslot anticollision sequence

The flow chart of PICC anticollision sequence is shown as below in Figure C.1.

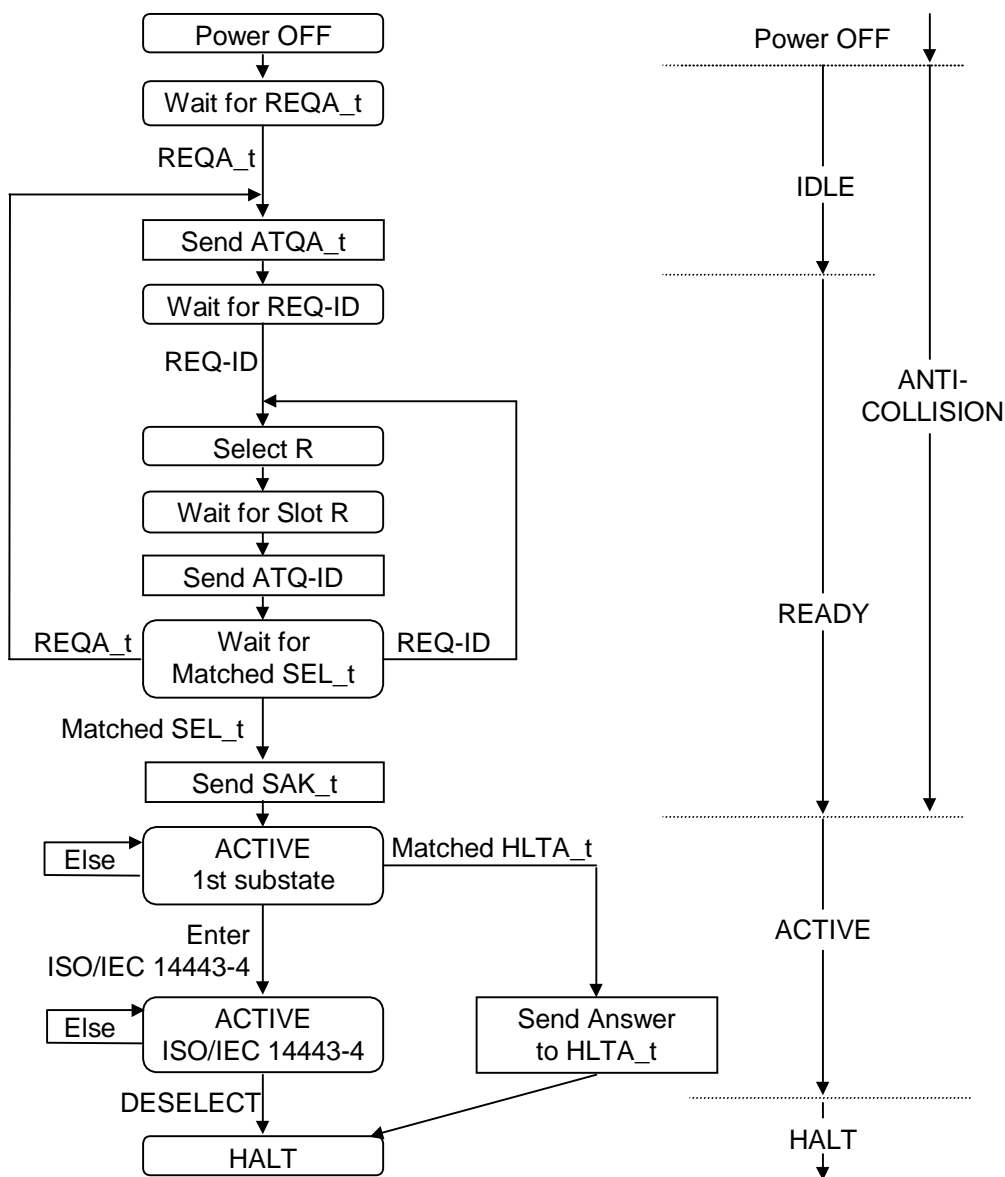
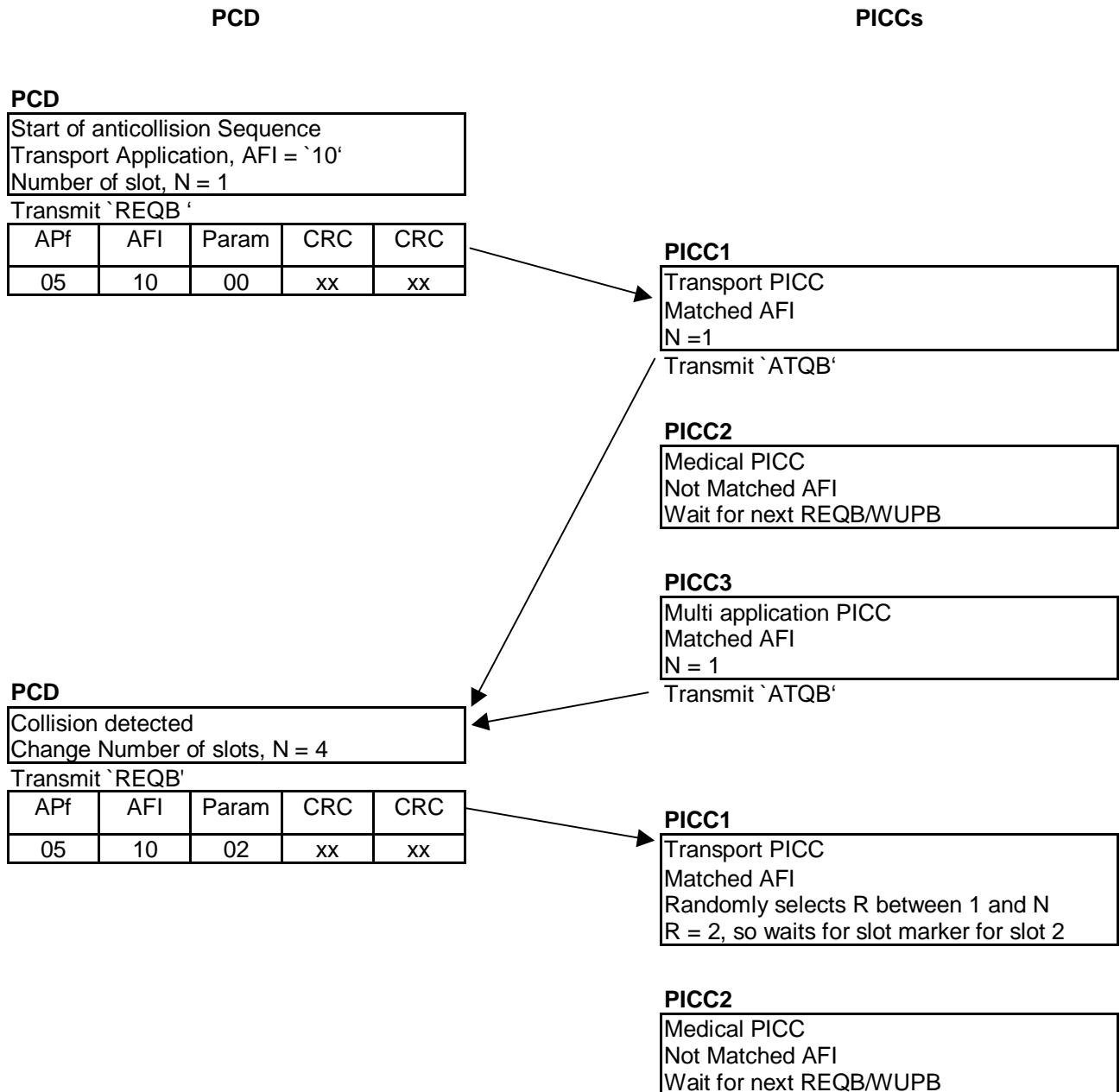

Figure C.1 — Flow chart of PICC anticollision sequence

## Annex D (informative)

### Type B - Example of Anticollision Sequence

NOTE Type B anticollision is a flexible set of commands to allow the anticollision strategy to be developed for the application.



Continued next page

